

RAISE YOUR GAME
HYVA **PERFORMANCE**



THE PERFECT SOLUTION
FOR APPLICATIONS
ON ALL VEHICLES





We Move your World

From light, compact machines, to solutions which deliver the ultimate levels of precision and lifting capacity, Hyva truck-mounted cranes are all built on the foundations of high performance, reliability, ease of use and safety. That's why they're among the most widely-used loader cranes in the world.

KENNIS ROLLOADER CRANES

Allowing the operator to cover a wide area with a limited number of extensions, Kennis cranes offer a number of significant advantages, including shorter loading and unloading times, high proximity to the load and high payloads. The crane can easily be removed from the trailer and installed on another. The rollover cranes from Kennis (cranes by Hyva) are renowned for their reliability and durability.

Hyva: Your Trusted Partner.



Hyva Worldwide

Founded in 1979, Hyva is today one of the world's leading providers of innovative and highly efficient transport solutions for the commercial vehicle and environmental service industries. With over 20,000 customers and more than 40% of the global front-end tipping cylinders segment for heavy duty trucks, the company operates in more than 110 countries, has more than 30 fully owned subsidiaries, and a manufacturing base that includes 12 production facilities across China, India, Brazil and Europe. We are committed to the development, production, marketing and distribution of solutions for the movement and transportation of goods.

The growth and success of Hyva is built on two key aspects of its operation: the quality and innovative nature of the company's solutions, and the excellence of its customer support. The first of these, product quality, is illustrated by the fact that Hyva today offers the strongest front-end hydraulic





telescopic cylinder in the world, as well as a full range of double acting cylinders, fixed mounted and rolling truck cranes, container lifting systems (hookloaders and skiploaders) and waste collection units. They are solutions which are used worldwide across a range of sectors including transport, construction, mining, materials handling and environmental services providers.

Service quality, too, is a fundamental part of the Hyva business philosophy: with operations in more than 110 countries, the company operates one of the world's most extensive customer support networks in the industry. It is a network which has earned Hyva an international reputation for excellence in customer care.





Full range of applications with Hyva Cranes



Building



Construction



Oil&Gas



Mining



Rental



Logistic



Gardening



Power
station



Maintenance



Waste
handling

Raise your game with our complete line of cranes

HA

From 1 to 11 tm class
Compact telescopic cranes

Page 32 to page 45

HT

From 9 to 24 tm class
Telescopic cranes:
easy to use

Page 46 to page 51

HB

From 3 to 70 tm class
User-friendly articulated cranes

Page 52 to page 85

HB-R

From 33 to 66 tm class
Large, user-friendly articulated cranes

Page 86 to page 93

TRAVE SERIE

From 13 to 45 tm class
In-Line trave cranes

Page 94 to page 99

HC

From 9 to 80 tm class
Best in class articulated cranes

Page 100 to page 163

HV

From 3 to 22 tm class
Cost and Performance perfect solutions

Page 164 to page 173

HW

From 6,2 tm class
Crane for waste collection

Page 174 to page 177

MAN BASKET

From 5 to 7 tm class
Crane for waste collection

Page 178 to page 181

FFB

From 1 to 5 tm class
Specialized cranes for agricultural tractors

Page 182 to page 187

KENNIS HYVA GROUP

From 13 to 40 tm class
Applications rollover cranes

Page 188 to page 197



Environmental protection

As part of our corporate responsibility Hyva is dedicated to protect the environment.

Painting filter

The air in and around the painting area is passed through a series of filters to remove the harmful chemicals from the air. Air quality is checked regularly to confirm correct operation of the system.

Heating system

Large spaces are more efficiently heated from below, rather than from above. In-floor heating is installed in most of our production area to make the most efficient use of energy.

ISO14001 Certification

Hyva is a certified ISO 9001 and ISO 14001 company by Lloyd's Register Quality Assurance (LRQA): the world's leading provider of independent assessment services including certification, validation, verification and training across a broad spectrum of standards and schemes, with recognition from over 50 accreditation bodies.

 <p>Lloyd's Register</p>	Control Issue Date: Issue Date: Expiry/Review Date:	2 November 2021 21 January 2022 23 October 2022	Digital approval: ISO 9001 - 12 May 2021
---	---	---	---

Certificate of Approval

This is to certify that the Management System of:

H.C.E. S.r.l. Unico Socio

Via Einstein, 4/R, 43028 Poviglio, Italy

has been approved by Lloyd's Register to the following standards:

ISO 9001:2015

Approval number(s): ISO 9001 - 0023011-008

This certificate forms part of the approval identified by approval number: 0023011

The scope of this approval is applicable to:

Design, manufacture, sales and after sales of hydraulically governed loader cranes for trucks and marine applications, Manufacture and service of truck loaders and roller cranes.



Paul Orzel
Area Operations Manager, Europe

Issued by: Lloyd's Register Nederland B.V.

Issued on behalf of: Lloyd's Register Quality Assurance Limited



Lloyd's Register Group Limited, its affiliated and associated companies (including Lloyd's Register Quality Assurance Limited (LRQA)), and their respective officers, employees or agents are, individually and collectively, referred to in this certificate as "Lloyd's Register". Lloyd's Register assumes no responsibility and shall not be liable in any manner for any damage or loss caused by reliance on the information or advice in this document or otherwise provided, unless the person has agreed in writing with the addressee that the addressee accepts the responsibility for the provision of this information or advice and for any such loss or liability, in connection with the terms and conditions set out in the relevant contract. Lloyd's Register (International) S.A. is a public limited liability company registered in the Netherlands. The Netherlands is not an official member state of the United Kingdom. Lloyd's Register Group Limited, 1 Trinity Park, Bishops Cleeve, Nottingham NG5 2BU, United Kingdom. The Netherlands is not an official member state of the United Kingdom.

Page 1 of 1

Preserving the earth for future generations

ISO14001 certification achieved by the factory in Poviglio (Italy) allowed Hyva to contribute to protect and preserve the environment in which we live.

In the last five years we have saved 212* tons of paper and preserved 3,180 trees. We have recycled 200* tons of wood. We saved 93,280,000* litres of drinking water. We recycled 58* tons of plastic saving 193* tons of oil.

In the last five years we saved 1,611,200* kwh and we recovered 183* tons of iron. We reduced CO2 emission in the air by 25%*.

* Certified source



From concept to field



Crane Design

Our research and development department uses the latest technology to design new products.

Each individual component of the crane is designed using a 3D CAD system which can test crane movements and ensure that it has a functional geometry.

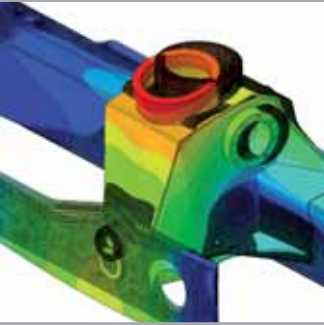

Structural verifications

During the design phase, FEM (Finite Element Method) is used to analyse the crane structure and loading conditions and obtain strength-to-weight optimisation.



Prototype development

Each component is checked for conformity to specification and assembled in a dedicated and specially equipped prototyping area.

And, every step is documented, with photographs, for precise tuning of the assembly process once it goes into production.



Tested in all conditions

Once assembled, every aspect of the prototype is fatigue tested. Every operating parameter is monitored by computer to detect any anomalies. Each prototype is subjected to up to 600,000 cycles of loading, to simulate 10 years of normal crane operations.



Field test

New cranes are delivered to expert users to be used in real, day-to-day operating conditions, including heavy duty applications. Direct communication between the user and R&D allows feedback for improvements. Cranes are launched only after a complete field testing programme.



Stability control systems (CE)

HS System

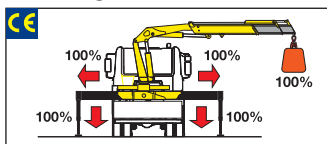

The **HS System** integrated in the load limiting device checks the stabilizers' positions. Only when all beams are fully open and all stabilizers are on the ground the crane can operate and lift loads.



Control display

HM System

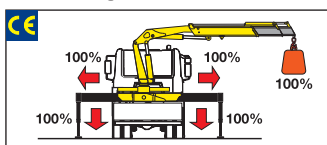

The **HM System** integrated in the load limiting device checks the stabilizers' positions. Only when all beams are fully open and all stabilizers are on the ground the crane can operate and lift loads.



Control display

HML System

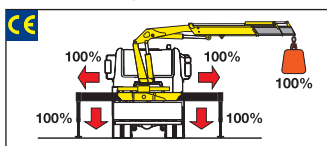

The **HML System** integrated in the load limiting device checks the stabilizers' positions. Only when all beams are fully open and all stabilizers are on the ground the crane can operate and lift loads.



HL System

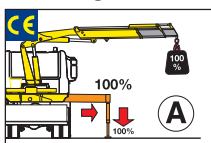

The **HL system** checks the stabilizers' positions and the truck's inclination.

According to the beams' positions, the system allows two operating modes:

Mode A - all beams fully open and all stabilizers feet on the ground.

Mode B - stabilizers on the ground only.

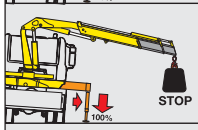
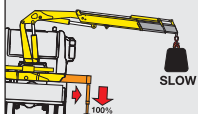
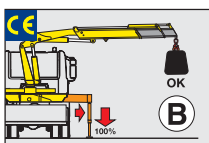

In **mode A**: the load limiting device stops the crane when the crane reaches 100% of the nominal capacity.

In **mode B**: a dedicated sensor monitors the truck's inclination. The load limiting device stops the crane before it reaches an inclination angle dangerous for stability, or when the crane reaches its nominal capacity.



Control display



HXL System

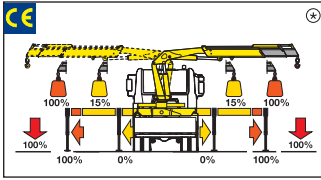

The TCU checks the positions of the stabilizers beams, monitoring for two possible positions: beam fully open, beam not fully open. Depending on the position of the beams and the stabilizers, the crane's lifting capacity changes according to the setting made by the installer. This allows the operator to use the crane even with a beam partially or fully retracted without having stability problems.

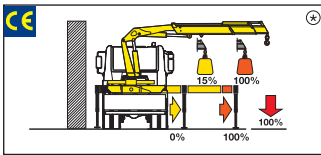

Optional HRCS

The Rotation Control Sensor constantly checks the slewing position of the crane and limits the lifting capacity depending on the beams' and the stabilizers positions.

⊛ The percentages present in the pictures are merely examples and they have no bearing on the cranes' real lifting capacities. The cranes' real lifting capacities will depend on truck's stability.

H2XL System

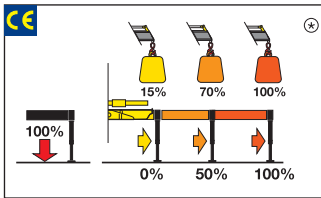

The TCU checks the positions of the stabilizers and divides the working area into 4 slewing sectors: over the cabin, right side, left side and the rear of the vehicle. Depending on the position of the beams and the stabilizers, the crane's lifting capacity changes according to the settings made by the installer. This allows the operator to use the crane even with a beam partially or fully retracted without having stability problems.



HPES The HPES (Proportional Encoder Sensor) recognizes 3 positions of the stabilizers' beams: fully open, half extended, fully closed.

HRCS The HRCS (Rotation Control Sensor) recognizes 4 slewing sectors: over the cabin, right side, left side, to the rear of the vehicle.

The CAN-BUS radio-control allows the operator to know the positions of the stabilizers and the loading conditions of the crane.



With manual opening stabilizers, the H2XL System only recognizes completely open or completely closed beam positions.

⊛ The percentages present in the pictures are merely examples and they have no bearing on the cranes' real lifting capacities. The cranes' real lifting capacities will depend on truck's stability.

Stability control systems (CE)

H3XL System



Display
3" graphic

H3XL

Beams
2 STEP
3 STEP

Slewing
PROPORTIONAL

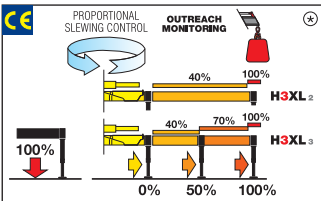

With a 3" TFT display and ergonomic keyboards, the operator can supervise the crane working and select the best parameters for effective use.

The H3XL system controls proportional slewing and the crane's stability, with 2-steps (H3XL₂) or 3-steps (H3XL₃) stabilizers outreach monitoring, depending by crane model and configuration.

⊛ The percentages present in the pictures are merely examples and they have no bearing on the cranes' real lifting capacities. The cranes' real lifting capacities will depend on truck's stability.

H4XL+TOP System



Display
7" graphic

Innovations
DLD -MT

H4XL

Beams
PROPORTIONAL

Slewing
PROPORTIONAL

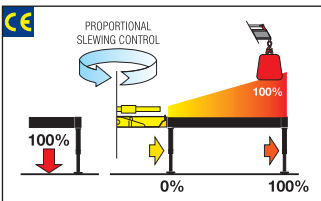

A 7" colour display with integrated keyboard gives the operator a higher level of awareness of the crane operation and allows selection of the best parameters for effective use.

The system detects the exact position of the beams and proportionally calculates the stability.

Stability control systems (CE) delivered standard with the crane

Models	HS	HM	HML	OPTIONAL HL	HXL	H2XL	H3XL	OPTIONAL H4XL
HA10								
HA14								
HA15	●		⊗	⊗				
HA21								
HA22	●		⊗	⊗				
HA27								
HA28	●		⊗	⊗				
HA33	●		⊗	⊗				
HA50		●	⊗	⊗				
HA70			⊗	⊗	●			
HT162							● ⊗	● ⊗
HT212							● ⊗	● ⊗
HT240							● ⊗	● ⊗
HB 31								
HB38								
HB40								
HB50		●	⊗	⊗				
HB60			⊗	⊗	●			
HB70			⊗	⊗	●			
HB80					●	⊗		
HB90							● ⊗	● ⊗
HB112							● ⊗	● ⊗
HB130							● ⊗	● ⊗
HB160							● ⊗	● ⊗
HB210							● ⊗	● ⊗
HB240							● ⊗	● ⊗
HB250					●	⊗		
HB280					●	⊗		
HC91							● ⊗	● ⊗
HC91K							● ⊗	● ⊗
HC103							⊗	⊗
HC111							● ⊗	● ⊗
HC111K							● ⊗	● ⊗

● Manual control ⊗ Radio Version

Stability control systems (CE) delivered standard with the crane

Models	HS	HM	HML	OPTIONAL HL	HXL	H2XL	H3XL	OPTIONAL H4XL
HC125							✕	✕
HC131							● ✕	● ✕
HC131K							● ✕	● ✕
HC153							✕	✕
HC161							● ✕	● ✕
HC161K							● ✕	● ✕
HC183							✕	✕
HC213							● ✕	● ✕
HC213K							● ✕	● ✕
HC231							✕	✕
HC243							● ✕	● ✕
HC243K							● ✕	● ✕
HC261							✕	✕
HC265e							✕	✕
HC291						● ✕		
HC331						● ✕		
HC361						● ✕		
HC401								✕
HC401K								✕
HC405e								✕
HC441								✕
HC445e								✕
HC501						✕		
HC601e								✕
HC661e								✕
HC801						✕		
HV27								
HV47		●						
HV77		●						
HV107		●						
HV147		●						
HV197		●						
HV227		●						

STANDARD

STANDARD

● Manual control ✕ Radio Version

Technical features

EES Extra Extension Speed

A special regenerative valve re-uses oil during extension, ensuring an incredibly high speed without compromising the safe operation of the crane.

Extensions speed comparison

Model	E2	E3	E4	E5
Standard	22"	32"	42"	51"
EES	10"	16"	22"	29"

SDS Smooth Descent System

This system compensates for boom oscillation, ensuring smooth movement of the load.

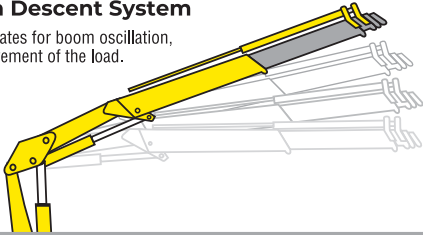

TCU Total Control Unit

TCU is a monitoring system designed by Hyva Crane to control all aspects of crane operation, including control of accessories. A display shows the user the state of the crane and easy on-board diagnostics allow the technician and dealer to inspect the activities of the crane.



LCS Lift Control System

Lift Control System increases the capacity of the crane up to 10% by reducing the speed when the crane is near its maximum lifting capacity.

P-LCS Proportional Lift Control System

The proportional system increase the capacity up to 15% by a proportional speed reduction when the crane is near to the maximum lifting capacity.

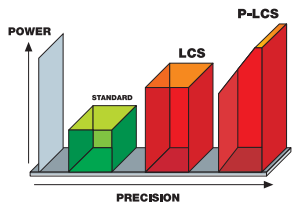

LAS Liftrod Articulating System

Thanks to the connecting rods the lifting capacity of the crane is constant in all boom positions.

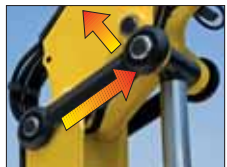

Radio Remote Controls

Multifunction radio controls



A wide range of radio control can be chosen: Scanreco, Hetronic and Autec



Hetronic Not CE



Scanreco



Hetronic CE Basic

CAN-Bus



Hetronic CE Graphic



4" TFT HD color display to keep the crane always under control

Operator can control the crane with high precision and fully supervise the loading and unloading operations.

■ Multifunction remote control



Electrohydraulic distributor:
HC-D4

■ Protected against radio interference



Pressure compensated control valve:
HAWE PLS2

■ Move around the truck freely



Pressure compensated control valve:
SAUER DANFOSS PVG32

Single hand proportional system The power in your hands



Pressure compensated inlet section: BOSCH

■ **Functionality**

Proportional speed control of any single movement

■ **Ergonomic**

Compact dimensions and reduced weight

■ **Comfort**

Single-handed control of every crane function

■ **Safety**
Stabilizer control by radio



Proportional speed control



EDGE^{LINE} RAISE YOUR GAME

NEW EDGE line cranes from Hyva, cutting edge innovation for 1st class lifting experience.

A new control station, incorporating both crane and stabiliser controls, has an ergonomic working position and user-friendly interface which delivers better operator efficiency and safety together with improved productivity.

Dynamic Load Diagram allows advance verification of the crane lifting capacity based on the truck stability, and, Magic Touch allows automatic folding and unfolding to transport and working positions.

There are several options for radio remote control and a wide range of stabiliser configurations to ensure safe positioning of the truck in all ground conditions.



The wide slewing angle, 425°, is best-in-class for medium sized cranes. And, with an extensive range of accessories and attachments, the cranes are suited to a wide range of applications.

Durability and lifetime value too is high with enhanced resistance to adverse environmental conditions as a result of a long life painting process, anti-corrosion treatments on non-painted components, protected rubber hose tracks and assembly of components using specialist tools.

**MT**

Magic Touch

Focus on innovation

A graphic display which allows the driver, after truck stabilisation, to automatically fold (from any position to transport position) and unfold (to working position) when required. This easy-to-use function improves driver attention, promotes safe operation, saves time and can increase productivity.



DLD Dynamic Load Diagram

Focus on innovation

A new system which allows the driver to verify in advance the crane lifting capacity based on the truck stability. The operator can select the weight and, according to the stabiliser positions, the system calculates the stability all around the truck. A graphical display shows the outreach available for the load selected and the actual boom slewing position. This system, a first on truck-mounted articulated cranes, optimises stabilisation and makes crane operation safer and more efficient. Easy to use, saves time and improves safety through better crane stabilisation and avoidance of border line working conditions.

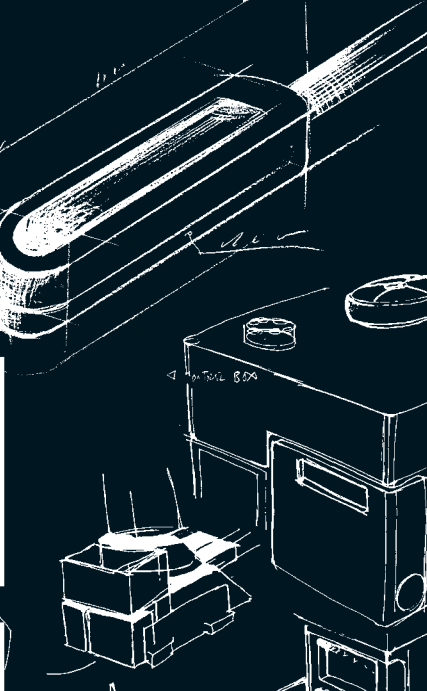

Functional aesthetic

High volume oil tank made in sandwich-structured materials.

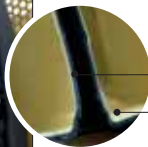

1st layer, PEX

2nd layer, PA6



New control station

The most ergonomic working position and user-friendly interface

Safe and fast stabilisation with outstanding supervision for operator.



CONNECTIVITY 4.0



THE POWER OF CONNECTIVITY 4.0 DISCOVER THE FEATURES & BENEFITS

Access all crane data through a simple factory or retrofit installation and a powerful Web interface. A gateway GPS reads and sends all data - analytics from crane sensors and electronics - to the Cloud for storage in an organised and secure manner.

Connectivity 4.0 is more than an accessory, it is an upgrade for your **Hyva EDGE crane** that will maximise performance and contribute to business growth in an easy but powerful way.

- **Efficiently manage and maintain your crane**
- **Obtain remote support which is focused, quick and efficient**
- **Improve control of your business**

MAXIMIZE YOUR ASSET PERFORMANCE



Connectivity 4.0 includes the gateway GPS (installed on the crane in factory or available as retrofit kit), SIM card with 5 years contract and full access to data on cloud portal (available from all devices).



REMOTE FIRMWARE UPGRADE

Latest firmware releases, direct from the factory, are always available. No delays, no wasted time.



REAL TIME MANAGEMENT

The Web portal - accessible from smartphone, tablet and other Internet-connected devices - shows real time crane data and functionality. This allows verification of crane parameters and sensor functionalities; analysis of alarms and warnings; and, remote resolution of issues arising.



MAPS

Locate your entire fleet, 24/7, with Geolocation functionality.



REPORTING

Reporting can analyse and display alarms and data from pressure and load functions as intuitive graphs. Statistical analyses improve crane maintenance and performance, through quick and easy functional monitoring, by preventing breakdowns or providing technical assistance.



PATHS

Paths displays live maps with crane routes plotted for the day or some other specified time period. Invaluable in improving daily job planning or reviewing transport cycles and working site visits.



REMOTE SET-UP

Remote set-up removes the need for a specialist technician to attend on site for every configuration adjustment to improve efficiency for a specific application. Similarly, troubleshooting and repair issues can often be successfully resolved remotely.



EVENTS LOG

Connectivity 4.0 saves all data, providing a log of events including alarms, warnings and sensors data. All information is then available to better check functionalities and build an accurate historical record.

NEW EDGE LINE EXTENDED WARRANTY

THE BEST WARRANTY CONDITIONS AVAILABLE IN THE INDUSTRY TODAY

With the EDGE Line we guarantee quality and reliability. All cranes have been fully tested with a rock solid development process: from market research to design, prototyping and field tests with users from different industries.

Hyva is proud to bring to you the **best warranty conditions available in the industry today guaranteed** with the quality and reliability of the EDGE Line.

3 YEARS GENERAL WARRANTY



STATE OF THE ART CONSTRUCTION

Hyva EDGE line incorporates the most robust materials, state of the art electronics and hydraulic components.

MADE IN THE HEART OF THE AUTOMOTIVE AND HYDRAULICS VALLEY

Fully manufactured with no compromise in Hyva plants in Italy, located in the heart of the “so called” automotive and hydraulics valley, which is the excellence of the workmanship available today not only in Italy, but in the World.

3 YEARS WARRANTY ON ALL COMPONENTS

All crane components not subjected to wear and tear, including painting, seals and hoses are covered by 3 years warranty. Exclusive Hyva conditions.

5 YEARS WARRANTY ON STRUCTURAL PARTS



STEEL IS GUARANTEED FOR 5 YEARS

Hyva EDGE Line offers 5 years warranty on structural parts: base, column, first boom, second boom, extensions, Jib, stabilizer beams, all the cylinders and pins, both for hook and winch operations.



EDGE

^{LINE}
RAISE YOUR GAME



HA

HA 10

HA 14

HA 15

HA 21

HA 22

HA 27

HA 28

HA 33

HA 50

HA 70

HA 111

Line of telescopic cranes made to satisfy customers in need of a crane which is compact, light and easy to operate

HA 10



HA10 E1						
kg	940*	875	490	320	235	
m	1,00	1,07	1,89	2,77	3,65	
HA10 E2						
kg	920*	810	460	315	235	
m	1,00	1,13	1,95	2,77	3,65	

CE	<input checked="" type="checkbox"/>
NO CE	<input checked="" type="checkbox"/>
MANUAL	<input checked="" type="checkbox"/>
RADIO	<input checked="" type="checkbox"/>

*) Theoretical lifting capacity

MODELS	LIFTING MOMENT	MAX VERTICAL REACH (HYDR)	SLEWING ANGLE	SLEWING TIME	MAX WORKING HEEL	WORKING PRESSURE	CRANE WEIGHT WITHOUT STABILIZERS	OIL TANK CAPACITY	OIL FLOW	DIMENSIONS
	tm	m	°	s/180°	°	bar	kg	l	l/min	mm B x h x S
HA10 E1	0,94	3,0	328	16	3	180	145	17,5	5	595x1240x370
HA10 E2	-	3,9	328	16	3	180	175	17,5	5	647x1240x370

HA 14



Model	kg	1280*	995	675	450	320
HA14 E1	m	1,00	1,07	1,89	2,77	3,65
HA14 E2	m	1,00	1,13	1,95	2,77	3,65

*) Theoretical lifting capacity

CE	<input checked="" type="checkbox"/>
NO CE	<input checked="" type="checkbox"/>
MANUAL	<input checked="" type="checkbox"/>
RADIO	<input checked="" type="checkbox"/>

MODELS	LIFTING MOMENT	MAX VERTICAL REACH (HYDR)	SLEWING ANGLE	SLEWING TIME	MAX WORKING HEEL	WORKING PRESSURE	CRANE WEIGHT WITHOUT STABILIZERS	OIL TANK CAPACITY	OIL FLOW	DIMENSIONS
	tm	m	°	s/180°	°	bar	kg	l	l/min	mm B x h x S
HA14 E1	1,28	3,0	335	10	3	160	174	17,5	8	620x1241x430
HA14 E2	-	3,8	335	10	3	160	193	17,5	8	672x1241x430

HA 15



HA15 E1						
kg	1280*	1195	675	450	320	
m	1,00	1,07	1,89	2,77	3,65	
HA15 E2						
kg	1260*	1115	635	440	320	
m	1,00	1,13	1,95	2,77	3,65	

*) Theoretical lifting capacity

CE	<input checked="" type="checkbox"/>
NO CE	<input checked="" type="checkbox"/>
MANUAL	<input checked="" type="checkbox"/>
RADIO	<input checked="" type="checkbox"/>

MODELS	LIFTING MOMENT	MAX VERTICAL REACH (HYDR)	SLEWING ANGLE	SLEWING TIME	MAX WORKING HEEL	WORKING PRESSURE	CRANE WEIGHT WITHOUT STABILIZERS	OIL TANK CAPACITY	OIL FLOW	DIMENSIONS
	tm	m	°	s/180°	°	bar	kg	l	l/min	mm B x h x S
HA15 E1	1,28	3,0	335	10	3	160	174	17,5	8	620x1241x430
HA15 E2	-	3,8	335	10	3	160	199	17,5	8	672x1241x430

HA 21



HA21 E1		kg 2000*	995	930	630	410	
		m 1,00	1,23	2,15	3,16	4,12	
HA21 E2		kg 1960*	995	880	620	410	
		m 1,00	1,31	2,23	3,16	4,12	
HA21 E3		kg 1740*	995	755	530	410	290
		m 1,00	1,38	2,31	3,23	4,16	5,11

*) Theoretical lifting capacity

CE	<input checked="" type="checkbox"/>
NO CE	<input type="checkbox"/>
MANUAL	<input checked="" type="checkbox"/>
RADIO	<input checked="" type="checkbox"/>

MODELS	LIFTING MOMENT	MAX VERTICAL REACH (HYDR)	SLEWING ANGLE	SLEWING TIME	MAX WORKING HEEL	WORKING PRESSURE	CRANE WEIGHT WITHOUT STABILIZERS	OIL TANK CAPACITY	OIL FLOW	DIMENSIONS
	tm	m	°	s/180°	°	bar	kg	l	l/min	
HA21 E1	2,00	3,6	335	10	3	160	216	17,5	8	695x1521x430
HA21 E2	-	4,5	335	10	3	160	240	17,5	8	710x1521x430
HA21 E3	-	5,5	335	10	3	150	262	17,5	8	868x1521x430

HA 22



HA22 E1

kg	2000*	1610	930	630	410
m	1,00	1,23	2,15	3,16	4,12

HA22 E2

kg	1970*	1505	880	620	410
m	1,00	1,31	2,23	3,16	4,12

HA22 E3

kg	1770*	1285	755	530	410	290
m	1,00	1,38	2,31	3,23	4,16	5,11

*) Theoretical lifting capacity

CE	<input checked="" type="checkbox"/>
NO CE	<input checked="" type="checkbox"/>
MANUAL	<input checked="" type="checkbox"/>
RADIO	<input checked="" type="checkbox"/>

MODELS	LIFTING MOMENT	MAX VERTICAL REACH (HYDR)	SLEWING ANGLE	SLEWING TIME	MAX WORKING HEEL	WORKING PRESSURE	CRANE WEIGHT WITHOUT STABILIZERS	OIL TANK CAPACITY	OIL FLOW	DIMENSIONS
	tm	m	°	s/180°	°	bar	kg	l	l/min	mm B x h x S
HA22 E1	2,00	3,6	335	10	3	160	216	17,5	8	695x1521x430
HA22 E2	-	4,5	335	10	3	160	243	17,5	8	710x1521x430
HA22 E3	-	5,5	335	10	3	150	265	17,5	8	868x1521x430

HA 27



Model	kg	2690*	995	995	830	610	
HA27 E1	m	1,00	1,32	2,25	3,24	4,24	
HA27 E2	kg	2660*	995	995	820	610	
m	1,00	1,39	2,32	3,24	4,24		
HA27 E3	kg	2580*	995	995	780	605	465
m	1,00	1,46	2,39	3,31	4,24	5,19	

*) Theoretical lifting capacity

CE	<input checked="" type="checkbox"/>
NO CE	<input type="checkbox"/>
MANUAL	<input checked="" type="checkbox"/>
RADIO	<input checked="" type="checkbox"/>

MODELS	LIFTING MOMENT	MAX VERTICAL REACH (HYDR)	SLEWING ANGLE	SLEWING TIME	MAX WORKING HEEL	WORKING PRESSURE	CRANE WEIGHT WITHOUT STABILIZERS	OIL TANK CAPACITY	OIL FLOW	DIMENSIONS
	tm	m	°	s/180°	°	bar	kg	l	l/min	mm B x h x S
HA27 E1	2,75	3,6	335	16	3	160	263	17,5	10	730x1587x440
HA27 E2	-	4,5	335	16	3	160	295	17,5	10	753x1587x440
HA27 E3	-	5,4	335	16	3	160	321	17,5	10	753x1587x440

HA 28



HA28 E1

kg	2750*	2085	1220	830	610
m	1,00	1,32	2,25	3,24	4,24

HA28 E2

kg	2720*	1960	1160	820	610
m	1,39	1,39	2,32	3,24	4,24

HA28 E3

kg	2710*	1855	1105	780	605	465
m	1,00	1,46	2,39	3,31	4,24	5,19

*) Theoretical lifting capacity

CE	<input checked="" type="checkbox"/>
NO CE	<input checked="" type="checkbox"/>
MANUAL	<input checked="" type="checkbox"/>
RADIO	<input checked="" type="checkbox"/>

MODELS	LIFTING MOMENT	MAX VERTICAL REACH (HYDR)	SLEWING ANGLE	SLEWING TIME	MAX WORKING HEEL	WORKING PRESSURE	CRANE WEIGHT WITHOUT STABILIZERS	OIL TANK CAPACITY	OIL FLOW	DIMENSIONS
	tm	m	°	s/180°	°	bar	kg	l	l/min	mm B x h x S
HA28 E1	2,75	3,6	335	16	3	160	263	17,5	10	730x1587x440
HA28 E2	-	4,5	335	16	3	160	298	17,5	10	753x1587x440
HA28 E3	-	5,4	335	16	3	160	323	17,5	10	753x1587x440

HA 33



HA33 E1		3450*	2420	1390	940	690	530	405
kg		1,00	1,42	2,48	3,62	4,75	5,89	6,99
m								
HA33 E2		3430*	2285	1320	930	690	530	405
kg		1,00	1,50	2,56	3,62	4,75	5,89	6,99
m								
HA33 E3		3380*	2155	1255	875	675	530	405
kg		1,00	1,57	2,63	3,69	4,75	5,89	6,99
m								
HA33 E4		3350*	2030	1190	830	635	520	405
kg		1,00	1,65	2,71	3,77	4,83	5,89	6,99
m								

CE	<input checked="" type="checkbox"/>
NO CE	<input checked="" type="checkbox"/>
MANUAL	<input checked="" type="checkbox"/>
RADIO	<input checked="" type="checkbox"/>

*) Theoretical lifting capacity

MODELS	LIFTING MOMENT	MAX VERTICAL REACH (HYDR)	SLEWING ANGLE	SLEWING TIME	MAX WORKING HEEL	WORKING PRESSURE	CRANE WEIGHT WITHOUT STABILIZERS	OIL TANK CAPACITY	OIL FLOW	DIMENSIONS
	tm	m	°	s/180°	°	bar	kg	l	l/min	
HA33 E1	3,45	3,9	395	16	3	175	305	17,5	10	976x1702x440
HA33 E2	-	5,0	395	16	3	175	339	17,5	10	1040x1702x440
HA33 E3	-	6,0	395	16	3	175	371	17,5	10	1040x1702x440
HA33 E4	-	7,0	395	16	3	175	399	17,5	10	1040x1702x440

HA 50



HA50 E2

kg	3850*	2135	1205	835	585
m	1,00	1,80	3,15	4,52	5,98

HA50 E3

kg	3760*	1980	1125	770	585	425
m	1,00	1,90	3,25	4,62	5,98	7,45

HA50 E4

kg	3630*	1810	1035	705	525	425	320
m	1,00	2,00	3,35	4,72	6,08	7,45	8,90

*) Theoretical lifting capacity

CE	<input checked="" type="checkbox"/>
NO CE	<input checked="" type="checkbox"/>
MANUAL	<input checked="" type="checkbox"/>
RADIO	<input checked="" type="checkbox"/>

MODELS	LIFTING MOMENT	MAX VERTICAL REACH (HYDR)	SLEWING ANGLE	SLEWING TIME	MAX WORKING HEEL	WORKING PRESSURE	CRANE WEIGHT WITHOUT STABILIZERS	OIL TANK CAPACITY	OIL FLOW	DIMENSIONS
	tm	m	°	s/180°	°	bar	kg	l	l/min	mm B x h x S
HA50 E2	3,85	7,3	380	15	4	220	605	35	16	2085x1855x470
HA50 E3	-	8,8	380	15	4	220	650	35	16	2085x1855x470
HA50 E4	-	10,2	380	15	4	220	690	35	16	2085x1855x470

HA 70



HA70 E2

kg	6730*	3380	1885	1300	935	690
m	1,00	1,99	3,55	5,10	6,75	8,40

HA70 E3

kg	6620*	3225	1790	1230	935	690	470
m	1,00	2,05	3,62	5,20	6,75	8,40	10,00

HA70 E4

kg	6530*	3035	1700	1150	865	690	470
m	1,00	2,15	3,73	5,30	6,85	8,40	10,00

*) Theoretical lifting capacity

CE	<input checked="" type="checkbox"/>
NO CE	<input checked="" type="checkbox"/>
MANUAL	<input checked="" type="checkbox"/>
RADIO	<input checked="" type="checkbox"/>

MODELS	LIFTING MOMENT	MAX VERTICAL REACH (HYDR)	SLEWING ANGLE	SLEWING TIME	MAX WORKING HEEL	WORKING PRESSURE	CRANE WEIGHT WITHOUT STABILIZERS	OIL TANK CAPACITY	OIL FLOW	DIMENSIONS
	tm	m	°	s/180°	°	bar	kg	l	l/min	mm B x h x S
HA70 E2	6,73	7,8	387	15	4	260	780	35	18	2310x1995x550
HA70 E3	-	9,3	387	15	4	260	840	35	18	2310x1995x550
HA70 E4	-	10,9	387	15	4	260	900	35	18	2310x1995x550

HA 111



HA111 E2

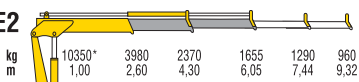

HA111 E3

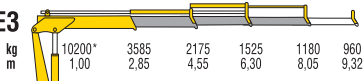

HA111 E4

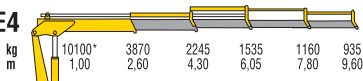

*) Theoretical lifting capacity

CE	<input checked="" type="checkbox"/>
NO CE	<input checked="" type="checkbox"/>
MANUAL	<input checked="" type="checkbox"/>
RADIO	<input checked="" type="checkbox"/>

Most recommended for car recovery trucks

MODELS	LIFTING MOMENT	MAX VERTICAL REACH (HYDR)	SLEWING ANGLE	SLEWING TIME	MAX WORKING HEEL	WORKING PRESSURE	CRANE WEIGHT WITHOUT STABILIZERS	OIL TANK CAPACITY	OIL FLOW	DIMENSIONS
	tm	m	°	s/180°	°	bar	kg	l	l/min	mm B x h x S
HA111 E2	10,3	9,5	395	17	4	295	1000	60	20	2350x2300x625
HA111 E3	-	11,5	395	17	4	295	1080	60	20	2350x2300x625
HA111 E4	-	13,0	395	17	4	295	1145	60	20	2350x2300x625





EDGE LINE
RAISE YOUR GAME

HT

HT 162

HT 212

HT 240

**Designed to be used in car recovery
and in all other applications where a
compact, light and easy to operate
crane is needed**

HT 162

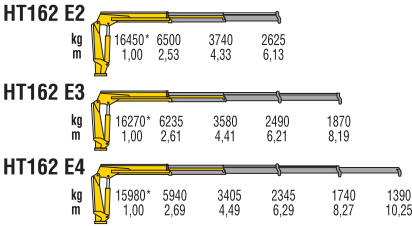
SDS

CE	<input checked="" type="checkbox"/>
NO CE	<input checked="" type="checkbox"/>
MANUAL	<input checked="" type="checkbox"/>
RADIO	<input checked="" type="checkbox"/>

*) Theoretical lifting capacity

MODELS	LIFTING MOMENT	MAX VERTICAL REACH (HYDR)	SLEWING ANGLE	SLEWING TIME	MAX WORKING HEEL	WORKING PRESSURE	CRANE WEIGHT WITHOUT STABILIZERS	OIL TANK CAPACITY	OIL FLOW	DIMENSIONS
	tm	m	°	s/180°	°	bar	kg	l	l/min	mm B x h x S
HT162 E2	16,5	9,8	425	12	4	290	1370	130	60	2485x2300x840
HT162 E3	-	11,8	425	12	4	290	1485	130	60	2485x2300x840
HT162 E4	-	13,8	425	12	4	290	1575	130	60	2485x2300x840

HT 212

SDS

HT212 E2

kg	20230*	8335	4790	3360
m	1,00	2,42	4,22	6,02

HT212 E3

kg	20770*	8250	4750	3400	2495
m	1,00	2,51	4,31	6,11	8,04

HT212 E4

kg	20540*	7930	4660	3250	2440	1895
m	1,00	2,59	4,39	6,19	8,13	10,07

HT212 E5

kg	19000*	7115	4220	2935	2170	1755	1375
m	1,00	2,67	4,47	6,27	8,21	10,15	12,08

*) Theoretical lifting capacity

CE	<input checked="" type="checkbox"/>
NO CE	<input checked="" type="checkbox"/>
MANUAL	<input checked="" type="checkbox"/>
RADIO	<input checked="" type="checkbox"/>

MODELS	LIFTING MOMENT	MAX VERTICAL REACH (HYDR)	SLEWING ANGLE	SLEWING TIME	MAX WORKING HEEL	WORKING PRESSURE	CRANE WEIGHT WITHOUT STABILIZERS	OIL TANK CAPACITY	OIL FLOW	DIMENSIONS
	tm	m	°	s/180°	°	bar	kg	l	l/min	mm B x h x S
HT212 E2	20,2	9,7	415	12	4	315	1680	130	70	2510x2400x870
HT212 E3	-	11,7	415	12	4	315	1825	130	70	2510x2400x870
HT212 E4	-	13,7	415	12	4	315	1945	130	70	2540x2400x870
HT212 E5	-	15,7	415	12	4	300	2040	130	70	2540x2400x870

HT 240

SDS
LCS

HT240 E2

kg	21070	8480	4930	3500
m	1,00*	2,42	4,22	6,02

HT240 E3

kg	21080	8390	4890	3440	2630
m	1,00*	2,51	4,31	6,11	8,04

HT240 E4

kg	20910	8075	4705	3295	2490	2000
m	1,00*	2,59	4,39	6,19	8,13	10,07

HT240 E5

kg	19440*	7250	4350	3020	2260	1820	1485
m	1,00	2,67	4,47	6,27	8,21	10,15	12,08

*) Theoretical lifting capacity

CE	<input checked="" type="checkbox"/>
NO CE	<input checked="" type="checkbox"/>
MANUAL	<input checked="" type="checkbox"/>
RADIO	<input checked="" type="checkbox"/>

MODELS	LIFTING MOMENT	MAX VERTICAL REACH (HYDR)	SLEWING ANGLE	SLEWING TIME	MAX WORKING HEEL	WORKING PRESSURE	CRANE WEIGHT WITHOUT STABILIZERS	OIL TANK CAPACITY	OIL FLOW	DIMENSIONS
	tm	m	°	s/180°	°	bar	kg	l	l/min	mm B x h x S
HT240 E2	20,5	9,7	415	12	4	335	1680	130	70	2520x2400x870
HT240 E3	-	11,7	415	12	4	335	1825	130	70	2520x2400x870
HT240 E4	-	13,7	415	12	4	335	1945	130	70	2540x2400x870
HT240 E5	-	15,7	415	12	4	320	2040	130	70	2540x2400x870





HB

HB 31	HB 152
HB 38	HB 160
HB 40	HB 170
HB 50	HB 202
HB 60	HB 210
HB 70	HB 230
HB 80	HB 240
HB 90	HB 250
HB 102	HB 280
HB 112	HB 460
HB 120	HB 700
HB 130	

The most versatile and user-friendly crane, simple, efficient and robust

HB 31



HB31 E1

kg	2610*	820	575	420	310
m	1,00	3,18	4,53	5,98	7,43

HB31 E2

kg	2510*	765	530	405	310
m	1,00	3,28	4,63	5,98	7,43

HB31 E3

kg	2420*	715	490	370	300	220
m	1,00	3,38	4,73	6,03	7,38	8,78

*) Theoretical lifting capacity

CE	<input checked="" type="checkbox"/>
NO CE	<input checked="" type="checkbox"/>
MANUAL	<input checked="" type="checkbox"/>
RADIO	<input checked="" type="checkbox"/>

MODELS	LIFTING MOMENT	MAX VERTICAL REACH (HYDR)	SLEWING ANGLE	SLEWING TIME	MAX WORKING HEEL	WORKING PRESSURE	CRANE WEIGHT WITHOUT STABILIZERS	OIL TANK CAPACITY	OIL FLOW	DIMENSIONS
	tm	m	°	s/180°	°	bar	kg	l	l/min	mm B x h x S
HB31 E1	2,61	6,98	370	10	4	175	390	25	8	1860x1590x490
HB31 E2	-	8,32	370	10	4	175	425	25	8	1920x1590x490
HB31 E3	-	9,66	370	10	4	175	455	25	8	2000x1590x490

HB 38



HB38 E1

kg	2760*	1360	865	610	450	335
m	1,00	2,00	3,18	4,53	5,98	7,43

HB38 E2

kg	2660*	1315	810	565	435	335
m	1,00	2,00	3,28	4,63	5,98	7,43

HB38 E3

kg	2570*	1265	760	525	400	325	235
m	1,00	2,00	3,38	4,73	6,03	7,38	8,78

*) Theoretical lifting capacity

CE	<input checked="" type="checkbox"/>
NO CE	<input checked="" type="checkbox"/>
MANUAL	<input checked="" type="checkbox"/>
RADIO	<input checked="" type="checkbox"/>

MODELS	LIFTING MOMENT	MAX VERTICAL REACH (HYDR)	SLEWING ANGLE	SLEWING TIME	MAX WORKING HEEL	WORKING PRESSURE	CRANE WEIGHT WITHOUT STABILIZERS	OIL TANK CAPACITY	OIL FLOW	DIMENSIONS
	tm	m	°	s/180°	°	bar	kg	l	l/min	mm B x h x S
HB38 E1	2,75	7,0	370	10	4	185	390	25	8	1860x1590x490
HB38 E2	-	8,3	370	10	4	185	425	25	8	1920x1590x490
HB38 E3	-	9,7	370	10	4	185	455	25	8	2000x1590x490

HB 40



HB40 E1

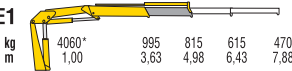

HB40 E2

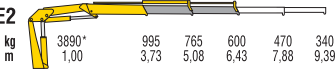

HB40 E3

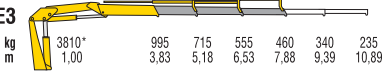

*) Theoretical lifting capacity

CE	<input checked="" type="checkbox"/>
NO CE	<input checked="" type="checkbox"/>
MANUAL	<input checked="" type="checkbox"/>
RADIO	<input checked="" type="checkbox"/>

MODELS	LIFTING MOMENT	MAX VERTICAL REACH (HYDR)	SLEWING ANGLE	SLEWING TIME	MAX WORKING HEEL	WORKING PRESSURE	CRANE WEIGHT WITHOUT STABILIZERS	OIL TANK CAPACITY	OIL FLOW	DIMENSIONS
	tm	m	°	s/180°	°	bar	kg	l	l/min	mm B x h x S
HB40 E1	4,06	7,75	370	15	3	215	515	30	16	1966x1780x500
HB40 E2	-	9,14	370	15	3	215	560	30	16	1966x1780x500
HB40 E3	-	10,51	370	15	3	215	600	30	16	2300x1780x620

HB 50



HB50 E1

kg	4730*	1890**	1300	950	700	520
m	1,00	2,43	3,63	4,98	6,43	7,88

HB50 E2

kg	4460*	1785**	1195	865	680	520	350
m	1,00	2,43	3,73	5,08	6,43	7,88	9,39

HB50 E3

kg	4250*	1700**	1110	800	620	510	350	240
m	1,00	2,43	3,83	5,18	6,53	7,88	9,39	10,89

*) Theoretical lifting capacity

**) Fixed hook capacity

CE	<input checked="" type="checkbox"/>
NO CE	<input checked="" type="checkbox"/>
MANUAL	<input checked="" type="checkbox"/>
RADIO	<input checked="" type="checkbox"/>

MODELS	LIFTING MOMENT	MAX VERTICAL REACH (HYDR)	SLEWING ANGLE	SLEWING TIME	MAX WORKING HEEL	WORKING PRESSURE	CRANE WEIGHT WITHOUT STABILIZERS	OIL TANK CAPACITY	OIL FLOW	DIMENSIONS
	tm	m	°	s/180°	°	bar	kg	l	l/min	mm B x h x S
HB50 E1	4,73	7,75	370	15	3	250	515	30	16	1966x1780x500
HB50 E2	-	9,14	370	15	3	250	560	30	16	1966x1780x500
HB50 E3	-	10,51	370	15	3	250	600	30	16	2300x1780x620

HB 60



Model	kg	1,00	2,45	3,78	5,34	7,00	8,64	10,30	11,90
HB60 E1	6580*	2680**	1740	1230	885	655			
HB60 E2	6410*	2615**	1650	1150	885	655	490		
HB60 E3	6160*	2515**	1555	1070	810	655	490	400	
HB60 E4	5970*	2435**	1475	995	745	590	495	400	

- CE**
- NO CE**
- MANUAL**
- RADIO**

*) Theoretical lifting capacity
 **) Fixed hook capacity

MODELS	LIFTING MOMENT	MAX VERTICAL REACH (HYDR)	SLEWING ANGLE	SLEWING TIME	MAX WORKING HEEL	WORKING PRESSURE	CRANE WEIGHT WITHOUT STABILIZERS	OIL TANK CAPACITY	OIL FLOW	DIMENSIONS
	tm	m	°	s/180°	°	bar	kg	l	l/min	mm B x h x S
HB60 E1	6,58	8,34	387	15	4	245	800	35	20	2240x1980x600
HB60 E2	-	9,81	387	15	4	245	870	35	20	2240x1980x600
HB60 E3	-	11,34	387	15	4	245	930	35	20	2240x1980x600
HB60 E4	-	12,90	387	15	4	245	980	35	20	2250x1980x600

HB 70



HB70 E1

kg	7170*	2925**	1865	1300	945	705	
m	1,00	2,45	3,84	5,40	7,02	8,66	

HB70 E2

kg	6870*	2805**	1760	1230	945	705	530
m	1,00	2,45	3,90	5,46	7,02	8,66	10,30

HB70 E3

kg	6620*	2700**	1675	1155	870	705	530	415
m	1,00	2,45	3,95	5,50	7,10	8,66	10,30	11,90

HB70 E4

kg	6470*	2620**	1585	1075	800	635	530	415
m	1,00	2,45	4,08	5,60	7,20	8,76	10,30	11,90

*) Theoretical lifting capacity
 **) Fixed hook capacity

CE	<input checked="" type="checkbox"/>
NO CE	<input checked="" type="checkbox"/>
MANUAL	<input checked="" type="checkbox"/>
RADIO	<input checked="" type="checkbox"/>

MODELS	LIFTING MOMENT	MAX VERTICAL REACH (HYDR)	SLEWING ANGLE	SLEWING TIME	MAX WORKING HEEL	WORKING PRESSURE	CRANE WEIGHT WITHOUT STABILIZERS	OIL TANK CAPACITY	OIL FLOW	DIMENSIONS
	tm	m	°	s/180°	°	bar	kg	l	l/min	
HB70 E1	7,17	8,50	387	15	4	265	820	35	20	2310x1980x600
HB70 E2	-	10,20	387	15	4	265	900	35	20	2310x1980x600
HB70 E3	-	11,70	387	15	4	265	960	35	20	2310x1980x600
HB70 E4	-	13,30	387	15	4	265	1020	35	20	2310x1980x600

HB 80



HB80 E1		kg 7890*	3220**	2050	1445	1050	790			
		m 1,00	2,45	3,85	5,40	7,05	8,66			
HB80 E2		kg 7690*	3140**	1965	1370	1050	790	600		
		m 1,00	2,45	3,90	5,46	7,05	8,66	10,35		
HB80 E3		kg 7420*	3030**	1865	1290	975	790	600	470	
		m 1,00	2,45	3,98	5,55	7,10	8,66	10,35	11,95	
HB80 E4		kg 7190*	2935**	1760	1200	900	715	600	470	
		m 1,00	2,45	4,08	5,65	7,20	8,76	10,35	11,95	

*) Theoretical lifting capacity

**) Fixed hook capacity

CE	<input checked="" type="checkbox"/>
NO CE	<input checked="" type="checkbox"/>
MANUAL	<input checked="" type="checkbox"/>
RADIO	<input checked="" type="checkbox"/>

MODELS	LIFTING MOMENT	MAX VERTICAL REACH (HYDR)	SLEWING ANGLE	SLEWING TIME	MAX WORKING HEEL	WORKING PRESSURE	CRANE WEIGHT WITHOUT STABILIZERS	OIL TANK CAPACITY	OIL FLOW	DIMENSIONS
	tm	m	°	s/180°	°	bar	kg	l	l/min	mm B x h x S
HB80 E1	7,89	8,50	387	15	4	285	850	35	20	2310x1980x600
HB80 E2	-	10,20	387	15	4	285	930	35	20	2310x1980x600
HB80 E3	-	11,70	387	15	4	285	990	35	20	2310x1980x600
HB80 E4	-	13,30	387	15	4	285	1050	35	20	2310x1980x600

HB 90

EES
SDS

HB90 E1

kg	8700*	4120*	3105**	2130	1510
m	1,00	2,00	2,68	4,08	5,76

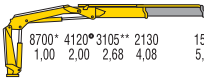
HB90 E2

kg	8240*	3900*	2990**	2020	1415	1095	710	600
m	1,00	2,00	2,68	4,08	5,76	7,45	9,41	11,21

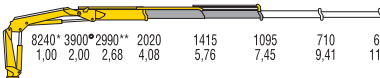
HB90 E3

kg	8010*	3780*	2900**	1920	1716	900	790	600	475
m	1,00	2,00	2,68	4,11	5,79	7,54	9,34	11,21	13,22

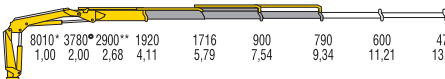
HB90 E4

kg	7840*	3680*	2840**	1850	1230	920	710	600	475
m	1,00	2,00	2,68	4,24	5,92	7,61	9,41	11,21	13,22

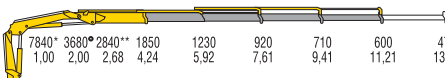

*) Theoretical lifting capacity **) Fixed hook capacity
 **) Fixed hook capacity *) Max lifting capacity

CE	<input checked="" type="checkbox"/>
NO CE	<input checked="" type="checkbox"/>
MANUAL	<input checked="" type="checkbox"/>
RADIO	<input checked="" type="checkbox"/>

MODELS	LIFTING MOMENT	MAX VERTICAL REACH (HYDR)	SLEWING ANGLE	SLEWING TIME	MAX WORKING HEEL	WORKING PRESSURE	CRANE WEIGHT WITHOUT STABILIZERS	OIL TANK CAPACITY	OIL FLOW	DIMENSIONS
	tm	m	°	s/180°	°	bar	kg	l	l/min	
HB90 E1	8,7	9,1	425	12	4	310	1030	75	40	2305X2070X840
HB90 E2	-	10,7	425	12	4	310	1110	75	40	2305X2070X840
HB90 E3	-	12,6	425	12	4	310	1190	75	40	2305X2070X840
HB90 E4	-	14,4	425	12	4	310	1260	75	40	2305X2070X840

HB 102

EES



HB102 E1

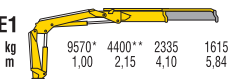

HB102 E2

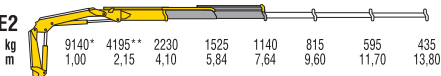

HB102 E3

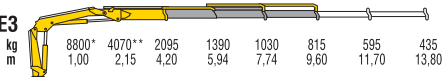

HB102 E4

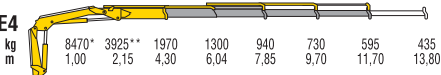

HB102 E5

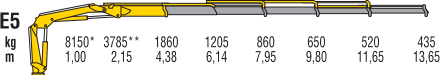

*) Theoretical lifting capacity
 **) Fixed hook capacity

CE	<input checked="" type="checkbox"/>
NO CE	<input checked="" type="checkbox"/>
MANUAL	<input checked="" type="checkbox"/>
RADIO	<input checked="" type="checkbox"/>

MODELS	LIFTING MOMENT	MAX VERTICAL REACH (HYDR)	SLEWING ANGLE	SLEWING TIME	MAX WORKING HEEL	WORKING PRESSURE	CRANE WEIGHT WITHOUT STABILIZERS	OIL TANK CAPACITY	OIL FLOW	DIMENSIONS
	tm	m	°	s/180°	°	bar	kg	l	l/min	mm B x h x S
HB 102 E1	9,6	9,45	395	12	4	290	1080	60	40	2475x2160x740
HB 102 E2	-	11,30	395	12	4	290	1185	60	40	2475x2160x740
HB 102 E3	-	13,20	395	12	4	290	1280	60	40	2475x2160x740
HB 102 E4	-	15,30	395	12	4	290	1370	60	40	2475x2160x740
HB 102 E5	-	17,30	395	12	4	290	1440	60	40	2475x2160x740

HB 112

EES
SDS

HB112 E1

kg	10580*	5000*	3830**	2580	1820
m	1,00	2,00	2,69	4,10	5,79

HB112 E2

kg	10170*	4780*	3680**	2475	1715	1320	865	720
m	1,00	2,00	2,69	4,11	5,79	7,48	9,36	11,23

HB112 E3

kg	9550*	4500*	3460**	2280	1565	1185	945	720	575
m	1,00	2,00	2,69	4,19	5,87	7,56	9,36	11,23	13,27

HB112 E4

kg	9570*	4360*	3350**	2170	1475	1100	865	715	575
m	1,00	2,00	2,69	4,27	5,95	7,64	9,44	11,24	13,27

*) Theoretical lifting capacity *) Max lifting capacity
 **) Fixed hook capacity

CE	<input checked="" type="checkbox"/>
NO CE	<input checked="" type="checkbox"/>
MANUAL	<input checked="" type="checkbox"/>
RADIO	<input checked="" type="checkbox"/>

MODELS	LIFTING MOMENT	MAX VERTICAL REACH (HYDR)	SLEWING ANGLE	SLEWING TIME	MAX WORKING HEEL	WORKING PRESSURE	CRANE WEIGHT WITHOUT STABILIZERS	OIL TANK CAPACITY	OIL FLOW	DIMENSIONS mm B x h x S
	tm	m	°	s/180°	°	bar	kg	l	l/min	
HB112 E1	10,5	9,2	425	12	4	310	1080	75	40	2310X2100X840
HB112 E2	-	10,8	425	12	4	310	1180	75	40	2310X2100X840
HB112 E3	-	12,6	425	12	4	310	1270	75	40	2310X2100X840
HB112 E4	-	14,4	425	12	4	310	1360	75	40	2310X2100X840

HB 120

EES



HB120 E1

kg	11830*	4825**	2790	1940
m	1,00	2,45	4,24	6,04

HB120 E2

kg	11250*	4560**	2605	1825	1375	1005	735	545
m	1,00	2,45	4,32	6,13	8,00	10,06	12,13	14,32

HB120 E3

kg	10960*	4415**	2485	1725	1275	1005	735	545	300
m	1,00	2,45	4,41	6,21	8,08	10,06	12,13	14,32	16,43

HB120 E4

kg	10670*	4295**	2370	1605	1170	895	735	545	300
m	1,00	2,45	4,50	6,30	8,17	10,15	12,13	14,32	16,44

HB120 E5

kg	10510*	4230**	2295	1555	1120	840	670	545	300
m	1,00	2,45	4,58	6,38	8,25	10,23	12,21	14,21	16,44

HB120 E3J2

kg						450	395	350	280
m						12,75	14,12	15,60	17,20

*) Theoretical lifting capacity
 **) Fixed hook capacity

CE	<input checked="" type="checkbox"/>
NO CE	<input checked="" type="checkbox"/>
MANUAL	<input checked="" type="checkbox"/>
RADIO	<input checked="" type="checkbox"/>

MODELS	LIFTING MOMENT	MAX VERTICAL REACH (HYDR)	SLEWING ANGLE	SLEWING TIME	MAX WORKING HEEL	WORKING PRESSURE	CRANE WEIGHT WITHOUT STABILIZERS	OIL TANK CAPACITY	OIL FLOW	DIMENSIONS
	tm	m	°	s/180°	°	bar	kg	l	l/min	mm B x h x S
HB120 E1	11,8	9,6	380	17	4	310	1285	100	25	2460x2340x885
HB120 E2	-	11,5	380	17	4	310	1415	100	25	2460x2340x885
HB120 E3	-	13,5	380	17	4	310	1535	100	25	2470x2340x885
HB120 E4	-	15,5	380	17	4	310	1635	100	25	2485x2340x885
HB120 E5	-	17,6	380	17	4	310	1705	100	25	2500x2340x940
HB120 E3J2	-	18,8	380	17	4	290	1835	100	25	2490x2340x1030

HB 130

EES
SDS

HB130 E1

kg	12440*	6000*	4540**	2740	1940
m	1,00	2,00	2,69	4,54	6,34

HB130 E2

kg	11850*	5720*	4330**	2610	1810	1395	1010	755	560
m	1,00	2,00	2,69	4,54	6,34	8,14	10,36	12,34	14,39

HB130 E3

kg	11430*	5520*	4180**	2475	1690	1280	1015	755	560	410
m	1,00	2,00	2,69	4,62	6,42	8,22	10,2	12,34	14,39	16,49

HB130 E4

kg	11090*	5330*	4050**	2355	1585	1175	910	755	560	410
m	1,00	2,00	2,69	4,71	6,51	8,31	10,29	12,27	14,39	16,49

HB130 E5

kg	10730*	5170*	3920**	2245	1490	1085	825	665	560	410
m	1,00	2,00	2,69	4,78	6,58	8,38	10,36	12,34	14,39	16,49

*) Theoretical lifting capacity **) Max lifting capacity
 **) Fixed hook capacity

CE	<input checked="" type="checkbox"/>
NO CE	<input checked="" type="checkbox"/>
MANUAL	<input checked="" type="checkbox"/>
RADIO	<input checked="" type="checkbox"/>

MODELS	LIFTING MOMENT	MAX VERTICAL REACH (HYDR)	SLEWING ANGLE	SLEWING TIME	MAX WORKING HEEL	WORKING PRESSURE	CRANE WEIGHT WITHOUT STABILIZERS	OIL TANK CAPACITY	OIL FLOW	DIMENSIONS
	tm	m	°	s/180°	°	bar	kg	l	l/min	
HB130 E1	12,4	9,9	425	12	4	285	1335	130	60	2480x2295x825
HB130 E2	-	11,7	425	12	4	285	1445	130	60	2480x2295x825
HB130 E3	-	13,7	425	12	4	285	1570	130	60	2480x2295x825
HB130 E4	-	15,7	425	12	4	285	1660	130	60	2480x2295x825
HB130 E5	-	17,8	425	12	4	285	1745	130	60	2480x2295x895

HB 152

EES

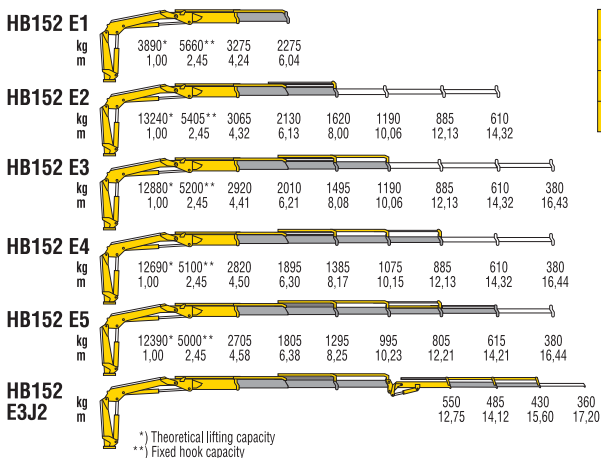

CE	<input checked="" type="checkbox"/>
NO CE	<input checked="" type="checkbox"/>
MANUAL	<input checked="" type="checkbox"/>
RADIO	<input checked="" type="checkbox"/>

MODELS	LIFTING MOMENT	MAX VERTICAL REACH (HYDR)	SLEWING ANGLE	SLEWING TIME	MAX WORKING HEEL	WORKING PRESSURE	CRANE WEIGHT WITHOUT STABILIZERS	OIL TANK CAPACITY	OIL FLOW	DIMENSIONS
	tm	m	°	s/180°	°	bar	kg	l	l/min	mm B x h x S
HB 152 E1	13,9	9,6	380	12	4	285	1510	100	25	2155x2340x855
HB 152 E2	-	11,5	380	12	4	285	1640	100	25	2455x2340x855
HB 152 E3	-	13,5	380	12	4	285	1760	100	25	2470x2340x855
HB 152 E4	-	15,5	380	12	4	285	1860	100	25	2485x2340x855
HB 152 E5	-	17,5	380	12	4	285	1950	100	25	2500x2340x910
HB 152 E3J2	-	18,8	380	12	4	285	2070	100	25	2490x2340x855

HB 160

EES
SDS

HB160 E1

kg	15840*	7650*	5270**	3490	2475
m	1,00	2,00	2,97	4,54	6,34

HB160 E2

kg	15030*	7250*	5000**	3310	2305	1775	1305	980	740
m	1,00	2,00	2,97	4,54	6,34	8,14	10,36	12,34	14,39

HB160 E3

kg	14550*	7030*	4840**	3150	2170	1645	1305	980	740	535
m	1,00	2,00	2,97	4,62	6,42	8,22	10,2	12,34	14,39	16,49

HB160 E4

kg	14150*	6810*	4700**	3005	2040	1520	1185	980	740	535
m	1,00	2,00	2,97	4,71	6,51	8,31	10,29	12,27	14,39	16,49

HB160 E5

kg	13740*	6620*	4560**	2875	1925	1410	1080	875	740	535
m	1,00	2,00	2,97	4,78	6,58	8,38	10,36	12,34	14,39	16,49

*) Theoretical lifting capacity **) Fixed hook capacity
 *) Max lifting capacity

CE	<input checked="" type="checkbox"/>
NO CE	<input checked="" type="checkbox"/>
MANUAL	<input checked="" type="checkbox"/>
RADIO	<input checked="" type="checkbox"/>

MODELS	LIFTING MOMENT	MAX VERTICAL REACH (HYDR)	SLEWING ANGLE	SLEWING TIME	MAX WORKING HEEL	WORKING PRESSURE	CRANE WEIGHT WITHOUT STABILIZERS	OIL TANK CAPACITY	OIL FLOW	DIMENSIONS
	tm	m	°	s/180°	°	bar	kg	l	l/min	
HB160 E1	15,8	9,9	425	12	4	280	1525	130	60	2490x2295x825
HB160 E2	-	11,7	425	12	4	280	1660	130	60	2490x2295x825
HB160 E3	-	13,7	425	12	4	280	1775	130	60	2490x2295x825
HB160 E4	-	15,7	425	12	4	280	1880	130	60	2490x2295x825
HB160 E5	-	17,8	425	12	4	280	1970	130	60	2490x2295x905

HB 170

EES
SDS



HB170 E1

kg	15760*	7470**	3700	2560
m	1,00	2,10	4,26	6,13

HB170 E2

kg	15340*	7215**	3600	2445	1850
m	1,00	2,10	4,26	6,13	8,00

HB170 E3

kg	15040*	7040**	3530	2355	1750	1380	1045	795	600
m	1,00	2,10	4,26	6,13	8,00	9,95	11,90	14,00	16,10

HB170 E4

kg	14680*	6900**	3445	2255	1640	1270	1045	795	600	460
m	1,00	2,10	4,26	6,13	8,00	9,95	11,90	14,00	16,10	18,30

HB170 E5

kg	14360*	6740**	3300	2130	1525	1170	940	795	600	460
m	1,00	2,10	4,35	6,22	8,10	10,05	12,00	14,00	16,10	18,30

HB170 E6

kg	14010*	6580**	3170	2030	1435	1070	850	700	600	460
m	1,00	2,10	4,42	6,30	8,16	10,10	12,10	14,10	16,10	18,30

HB170 E4J2

kg									535	480	435	360
m									14,60	16,00	17,50	19,10

CE	<input checked="" type="checkbox"/>
NO CE	<input checked="" type="checkbox"/>
MANUAL	<input checked="" type="checkbox"/>
RADIO	<input checked="" type="checkbox"/>

*) Theoretical lifting capacity
**) Fixed hook capacity

HB 170



EES Extra Extension Speed
SDS Smooth Descent System

MODELS	LIFTING MOMENT	MAX VERTICAL REACH (HYDR)	SLEWING ANGLE	SLEWING TIME	MAX WORKING HEEL	WORKING PRESSURE	CRANE WEIGHT WITHOUT STABILIZERS	OIL TANK CAPACITY	OIL FLOW	DIMENSIONS
	tm	m	°	s/180°	°	bar	kg	l	l/min	mm B x h x S
HB170 E1	15,8	9,9	387	17	4	310	1770	130	32	2480x2295x970
HB170 E2	-	11,8	387	17	4	310	1910	130	32	2480x2295x970
HB170 E3	-	13,8	387	17	4	310	2030	130	32	2480x2295x1000
HB170 E4	-	15,7	387	17	4	310	2150	130	32	2480x2295x1000
HB170 E5	-	17,8	387	17	4	310	2260	130	32	2480x2295x1000
HB170 E6	-	19,8	387	17	4	310	2340	130	32	2495x2295x1000
HB170 E4J2	-	21,2	387	17	4	310	2460	130	32	2480x2295x1120

HB 202

EES



HB202 E1

kg	19620*	9210**	4605	3200
m	1,00	2,10	4,26	6,13

HB202 E2

kg	19170*	9060**	4500	3095	2325
m	1,00	2,10	4,26	6,13	8,00

HB202 E3

kg	18660*	8750**	4380	2945	2205	1745	1325	1005	770
m	1,00	2,10	4,26	6,13	8,00	9,95	11,90	14,00	16,10

HB202 E4

kg	18210*	8575**	4275	2845	2085	1605	1325	1005	770	550
m	1,00	2,10	4,26	6,13	8,00	9,95	11,90	14,00	16,10	18,30

HB202 E5

kg	17790*	8370**	4090	2680	1940	1490	1195	1005	770	550
m	1,00	2,10	4,35	6,22	8,10	10,05	12,00	14,00	16,10	18,30

HB202 E6

kg	17390*	8190**	3935	2570	1840	1395	1105	915	775	550
m	1,00	2,10	4,42	6,30	8,16	10,10	12,10	14,10	16,10	18,30

HB202 E5J2

kg									550	500	450	380
m									16,70	18,10	19,60	21,10

CE	<input type="checkbox"/>
NO CE	<input checked="" type="checkbox"/>
MANUAL	<input checked="" type="checkbox"/>
RADIO	<input checked="" type="checkbox"/>

*) Theoretical lifting capacity
 **) Fixed hook capacity

HB 202



EES Extra Extension Speed

MODELS	LIFTING MOMENT	MAX VERTICAL REACH (HYDR)	SLEWING ANGLE	SLEWING TIME	MAX WORKING HEEL	WORKING PRESSURE	CRANE WEIGHT WITHOUT STABILIZERS	OIL TANK CAPACITY	OIL FLOW	DIMENSIONS
	tm	m	°	s/180°	°	bar	kg	l	l/min	mm B x h x S
HB 202 E1	19,3	9,9	387	12	4	300	1860	130	40	2165x2295x970
HB 202 E2	-	11,8	387	12	4	300	2010	130	40	2210x2295x970
HB 202 E3	-	13,7	387	12	4	300	2150	130	40	2275x2295x1000
HB 202 E4	-	15,7	387	12	4	300	2280	130	40	2370x2295x1000
HB 202 E5	-	17,7	387	12	4	300	2380	130	40	2440x2295x1000
HB 202 E6	-	19,8	387	12	4	300	2480	130	40	2495x2295x1000
HB 202 E5J2	-	23,3	387	12	4	300	2715	130	40	2480x2300x1000

HB 210

EES
SDS



HB210 E2

kg	18940*	8000*	4405	3000	2280
m	1,00	2,27	4,30	6,20	8,10

HB210 E3

kg	18580*	8000*	4320	2970	2230	1700	1280	980	770
m	1,00	2,21	4,30	6,20	8,10	10,13	12,25	14,46	16,59

HB210 E4

kg	18000*	8000*	4100	2830	2120	1625	1280	980	770	630
m	1,00	2,14	4,39	6,29	8,19	10,22	12,25	14,46	16,59	18,70

HB210 E5

kg	17610*	8000*	3940	2585	1880	1440	1165	980	770	630
m	1,00	2,09	4,47	6,37	8,27	10,30	12,33	14,46	16,59	18,70

CE	<input checked="" type="checkbox"/>
NO CE	<input checked="" type="checkbox"/>
MANUAL	<input checked="" type="checkbox"/>
RADIO	<input checked="" type="checkbox"/>

*) Theoretical lifting capacity *) Max lifting capacity

HB 210



EES Extra Extension Speed
SDS Smooth Descent System

MODELS	LIFTING MOMENT	MAX VERTICAL REACH (HYDR)	SLEWING ANGLE	SLEWING TIME	MAX WORKING HEEL	WORKING PRESSURE	CRANE WEIGHT WITHOUT STABILIZERS	OIL TANK CAPACITY	OIL FLOW	DIMENSIONS
	tm	m	°	s/180°	°	bar	kg	l	l/min	mm B x h x S
HB210 E2	22,7	11,9	415	12	4	315	2040	130	70	2520X2300X930
HB210 E3	-	13,9	415	12	4	315	2190	130	70	2520X2300X930
HB210 E4	-	16,1	415	12	4	315	2335	130	70	2520X2300X930
HB210 E5	-	18,2	415	12	4	315	2450	130	70	2520X2300X930

HB 230

EES

SDS

LCS



HB230 E1

kg	20660*	9620**	4765	3370
m	1,00	2,10	4,26	6,13

HB230 E2

kg	19980*	9415**	4665	3260	2490
m	1,00	2,10	4,26	6,13	8,00

HB230 E3

kg	19300*	9140**	4530	3095	2355	1905	1470	1145	905
m	1,00	2,10	4,26	6,13	8,00	9,95	11,90	14,00	16,10

HB230 E4

kg	18870*	8935**	4430	2995	2225	1755	1470	1145	905	650
m	1,00	2,10	4,26	6,13	8,00	9,95	11,90	14,00	16,10	18,30

HB230 E5

kg	18420*	8720**	4235	2820	2075	1635	1330	1145	905	650
m	1,00	2,10	4,35	6,22	8,10	10,05	12,00	14,00	16,10	18,30

HB230 E6

kg	18030*	8525**	4080	2700	1970	1535	1230	1045	905	650
m	1,00	2,10	4,42	6,30	8,16	10,10	12,10	14,10	16,10	18,30

HB230 E5J2

kg									605	550	505	400
m									16,70	18,10	19,60	21,10

CE	<input checked="" type="checkbox"/>
NO CE	<input checked="" type="checkbox"/>
MANUAL	<input checked="" type="checkbox"/>
RADIO	<input checked="" type="checkbox"/>

*) Theoretical lifting capacity
 **) Fixed hook capacity

HB 230



EES Extra Extension Speed
SDS Smooth Descent System
LCS Lift Control System

MODELS	LIFTING MOMENT	MAX VERTICAL REACH (HYDR)	SLEWING ANGLE	SLEWING TIME	MAX WORKING HEEL	WORKING PRESSURE	CRANE WEIGHT WITHOUT STABILIZERS	OIL TANK CAPACITY	OIL FLOW	DIMENSIONS
	tm	m	°	s/180°	°	bar	kg	l	l/min	mm B x h x S
HB230 E1	20,7	9,9	387	17	4	315	1890	130	40	2480x2295x970
HB230 E2	-	11,8	387	17	4	315	2040	130	40	2480x2295x970
HB230 E3	-	13,8	387	17	4	315	2180	130	40	2480x2295x1000
HB230 E4	-	15,7	387	17	4	315	2310	130	40	2480x2295x1000
HB230 E5	-	17,8	387	17	4	315	2410	130	40	2480x2295x1000
HB230 E6	-	19,8	387	17	4	315	2510	130	40	2480x2295x1000
HB230 E5J2	-	23,3	387	17	4	315	2745	130	40	2480x2300x1120

HB 240

EES
SDS



HB240 E2

kg	22700*	8000*	5280	3610	2750
m	1,00	2,75	4,30	6,20	8,10

HB240 E3

kg	21870*	8000*	5085	3425	2570	2035	1530	1170	770
m	1,00	2,64	4,30	6,20	8,10	10,13	12,25	14,46	16,59

HB240 E4

kg	21160*	8000*	4820	3215	2380	1860	1530	1170	915	735
m	1,00	2,55	4,39	6,29	8,19	10,22	12,25	14,46	16,59	18,70

HB240 E5

kg	21490*	8000*	4585	3035	2220	1710	1390	1170	915	735
m	1,00	2,46	4,47	6,37	8,27	10,30	12,33	14,46	16,59	18,70

CE	<input checked="" type="checkbox"/>
NO CE	<input checked="" type="checkbox"/>
MANUAL	<input checked="" type="checkbox"/>
RADIO	<input checked="" type="checkbox"/>

*) Theoretical lifting capacity
**) Fixed hook capacity
●) Max lifting capacity

HB 240



EES Extra Extension Speed
SDS Smooth Descent System

MODELS	LIFTING MOMENT	MAX VERTICAL REACH (HYDR)	SLEWING ANGLE	SLEWING TIME	MAX WORKING HEEL	WORKING PRESSURE	CRANE WEIGHT WITHOUT STABILIZERS	OIL TANK CAPACITY	OIL FLOW	DIMENSIONS
	tm	m	°	s/180°	°	bar	kg	l	l/min	mm B x h x S
HB240 E2	22,7	11,9	415	12	4	320	2200	130	80	2520X2300X930
HB240 E3	-	13,9	415	12	4	320	2355	130	80	2520X2300X930
HB240 E4	-	16,0	415	12	4	320	2505	130	80	2520X2300X930
HB240 E5	-	18,2	415	12	4	320	2625	130	80	2520X2300X930

HB 250



HB250 E1

kg	25070*	9580**	5830	4065	2895	2160	1620	1255
m	1,00	2,55	4,30	6,07	7,93	9,82	11,82	13,90

HB250 E2

kg	24670*	9480**	5725	3890	2895	2160	1620	1255
m	1,00	2,55	4,31	6,08	7,93	9,82	11,82	13,87

HB250 E3

kg	24030*	9275**	5575	3740	2750	2160	1620	1255	1005
m	1,00	2,55	4,31	6,08	7,93	9,83	11,82	13,88	15,95

HB250 E4

kg	23390*	9070**	5315	3535	2570	1985	1620	1255	1005	850
m	1,00	2,55	4,40	6,17	8,02	9,92	11,82	13,88	15,95	17,75

HB250 E5

kg	22890*	8970**	5110	3390	2425	1865	1500	1255	1005	850
m	1,00	2,55	4,48	6,25	8,10	10,00	11,90	13,88	15,95	17,75

HB250 E6

kg	22860*	8950**	5035	3320	2375	1805	1445	1205	965	780
m	1,00	2,55	4,54	6,31	8,16	10,06	11,96	13,94	15,92	17,81

HB250

E3J3

kg						1105	925	805	700	500
m						12,30	13,90	15,50	17,20	19,00

HB250

E4J3

kg							835	745	630	565	480
m							14,30	15,80	17,50	19,10	20,90

*) Theoretical lifting capacity
 **) Fixed hook capacity

CE	<input checked="" type="checkbox"/>
NO CE	<input checked="" type="checkbox"/>
MANUAL	<input checked="" type="checkbox"/>
RADIO	<input checked="" type="checkbox"/>

HB 250



MODELS	LIFTING MOMENT	MAX VERTICAL REACH (HYDR)	SLEWING ANGLE	SLEWING TIME	MAX WORKING HEEL	WORKING PRESSURE	CRANE WEIGHT WITHOUT STABILIZERS	OIL TANK CAPACITY	OIL FLOW	DIMENSIONS
	tm	m	°	s/180°	°	bar	kg	l	l/min	mm B x h x S
HB250 E1	25,1	9,8	400	20	4	290	2580	160	50	2540x2320x1115
HB250 E2	-	11,6	400	20	4	290	2760	160	50	2540x2320x1115
HB250 E3	-	13,4	400	20	4	290	2900	160	50	2540x2320x1115
HB250 E4	-	15,3	400	20	4	290	3060	160	50	2540x2320x1115
HB250 E5	-	17,3	400	20	4	290	3200	160	50	2540x2320x1115
HB250 E6	-	19,3	400	20	4	290	3295	160	50	2540x2320x1115
HB250 E3J3	-	20,2	400	25	4	290	3450	160	50	2540x2430x1300
HB250 E4J3	-	22,1	400	25	4	295	3600	160	50	2540x2445x1300

HB 280

LCS



HB280 E1

kg	25820*	9785**	6005	4245	3055	2300	1750	1375
m	1,00	2,55	4,30	6,07	7,93	9,82	11,82	13,90

HB280 E2

kg	25430*	9685**	5900	4065	3055	2300	1750	1375
m	1,00	2,55	4,31	6,08	7,93	9,82	11,81	13,87

HB280 E3

kg	24780*	9530**	5750	3900	2905	2300	1750	1375	1115
m	1,00	2,55	4,31	6,08	7,93	9,83	11,82	13,88	15,95

HB280 E4

kg	24070*	9325**	5470	3685	2710	2120	1750	1375	1115	955
m	1,00	2,55	4,40	6,17	8,02	9,92	11,82	13,88	15,95	17,75

HB280 E5

kg	23650*	9175**	5275	3545	2570	1995	1620	1365	1115	955
m	1,00	2,55	4,48	6,25	8,10	10,00	11,90	13,88	15,95	17,75

HB280 E6

kg	23650*	9125**	5210	3470	2510	1925	1560	1315	1065	870
m	1,00	2,55	4,54	6,31	8,16	10,06	11,96	13,94	15,92	17,81

HB280 E3J3

kg							1205	1005	885	780	555
m							12,30	13,90	15,50	17,20	19,00

HB280 E4J3

kg								935	830	700	630	530
m								14,30	15,80	17,50	19,10	20,90

CE	<input checked="" type="checkbox"/>
NO CE	<input checked="" type="checkbox"/>
MANUAL	<input checked="" type="checkbox"/>
RADIO	<input checked="" type="checkbox"/>

*) Theoretical lifting capacity
 **) Fixed hook capacity

HB 280



LCS Lift Control System

MODELS	LIFTING MOMENT	MAX VERTICAL REACH (HYDR)	SLEWING ANGLE	SLEWING TIME	MAX WORKING HEEL	WORKING PRESSURE	CRANE WEIGHT WITHOUT STABILIZERS	OIL TANK CAPACITY	OIL FLOW	DIMENSIONS
	tm	m	°	s/180°	°	bar	kg	l	l/min	mm B x h x S
HB280 E1	25,8	9,8	400	20	4	305	2630	160	50	2540x2320x1115
HB280 E2	-	11,6	400	20	4	305	2810	160	50	2540x2320x1115
HB280 E3	-	13,4	400	20	4	305	2950	160	50	2540x2320x1115
HB280 E4	-	15,3	400	20	4	305	3110	160	50	2540x2320x1115
HB280 E5	-	17,3	400	20	4	305	3250	160	50	2540x2320x1115
HB280 E6	-	19,3	400	20	4	305	3345	160	50	2540x2320x1115
HB280 E3J3	-	20,2	400	25	4	295	3500	160	50	2540x2430x1300
HB280 E4J3	-	22,1	400	25	4	295	3650	160	50	2540x2445x1300

HB 460

EES
SDS
LAS



HB460 E2

kg	43420*	22150*	10485	7360	5590
m	1,00	1,95	4,12	5,90	7,75

HB460 E3

kg	42350*	21720*	10010	7025	5310	4220	3270	2565	2040
m	1,00	1,95	4,23	6,00	7,85	9,80	11,80	13,90	16,00

HB460 E4

kg	41780*	21425*	9600	6710	5020	3955	3270	2565	2040	1605
m	1,00	1,95	4,35	6,10	7,95	9,90	11,80	13,90	16,00	18,20

HB460 E5

kg	41400*	21230*	9410	6505	4795	3720	3040	2565	2040	1605	1260
m	1,00	1,95	4,35	6,10	7,95	9,90	11,80	13,90	16,00	18,20	20,40

HB460 E6

kg	40050*	20540*	9095	6245	4580	3515	2845	2360	2040	1605	1260	1005
m	1,00	1,95	4,40	6,15	8,00	9,90	11,90	13,90	16,00	18,20	20,40	22,60

HB460 E7

kg	39230*	20120*	8915	6050	4385	3325	2640	2170	1840	1605	1260	1005
m	1,00	1,95	4,40	6,15	8,00	9,90	11,90	13,90	16,00	18,20	20,40	22,60

HB460 E8

kg	38550*	19770*	8560	5800	4180	3140	2460	1975	1660	1425	1260	1005
m	1,00	1,95	4,50	6,20	8,10	10,00	12,00	14,00	16,10	18,20	20,40	22,60

*) Theoretical lifting capacity

CE	<input type="checkbox"/>
NO CE	<input checked="" type="checkbox"/>
MANUAL	<input checked="" type="checkbox"/>
RADIO	<input type="checkbox"/>

HB 460



EES Extra Extension Speed
SDS Smooth Descent System
LAS Liftrod Articulating System

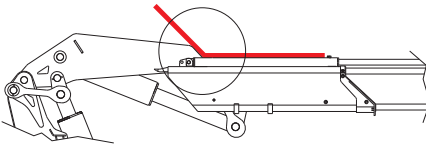

Second boom with negative angle in order to simplify operations in difficult access conditions

MODELS	LIFTING MOMENT	MAX VERTICAL REACH (HYDR)	SLEWING ANGLE	SLEWING TIME	MAX WORKING HEEL	WORKING PRESSURE	CRANE WEIGHT WITHOUT STABILIZERS	OIL TANK CAPACITY	OIL FLOW	DIMENSIONS
	tm	m	°	s/180°	°	bar	kg	l	l/min	mm B x h x S
HB460 E2	43,4	12,1	400	22	4	305	4040	210	50	2505x2460x1275
HB460 E3	-	14,1	400	22	4	305	4290	210	50	2505x2460x1275
HB460 E4	-	16,1	400	22	4	305	4570	210	50	2505x2460x1275
HB460 E5	-	18,2	400	22	4	305	4810	210	50	2505x2460x1285
HB460 E6	-	20,3	400	22	4	305	5010	210	50	2505x2460x1285
HB460 E7	-	22,5	400	22	4	305	5200	210	50	2505x2460x1400
HB460 E8	-	24,7	400	22	4	305	5380	210	50	2510x2480x1400

HB 700

EES

SDS

LAS



HB700 E2

kg	69840*	23280*	16890	12050	9250
m	1,00	3,00	4,05	5,75	7,55

HB700 E4

kg	66300*	22100*	16090	11330	8570	6800	5640
m	1,00	3,00	4,12	5,85	7,65	9,55	11,45

HB700 E6

kg	64350*	21450*	15070	10540	7840	6120	5030	4210	3640	2730	2420	1770
m	1,00	3,00	4,27	6,00	7,77	9,70	11,60	13,60	15,60	17,60	19,60	22,00

HB700 E8

kg	62550*	20850*	14650	10120	7400	5660	4520	3710	3130	2730	2420	1770	1610	1265
m	1,00	3,00	4,27	6,00	7,77	9,70	11,60	13,60	15,60	17,60	19,60	22,00	24,15	26,50

HB700 E10

kg	61980*	20660*	13620	9390	6840	5160	4060	3260	2710	2320	2020	1770	1610	1265
m	1,00	3,00	4,55	6,25	8,05	10,00	11,85	13,85	15,85	17,85	19,85	22,00	24,15	26,50

*) Theoretical lifting capacity

CE	<input type="checkbox"/>
NO CE	<input checked="" type="checkbox"/>
MANUAL	<input checked="" type="checkbox"/>
RADIO	<input type="checkbox"/>

HB 700



EES Extra Extension Speed
SDS Smooth Descent System
LAS Liftrod Articulating System

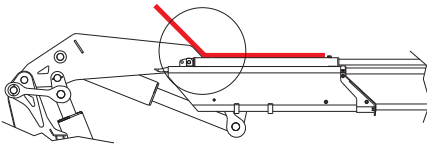

Second boom with negative angle in order to simplify operations in difficult access conditions

MODELS	LIFTING MOMENT	MAX VERTICAL REACH (HYDR)	SLEWING ANGLE	SLEWING TIME	MAX WORKING HEEL	WORKING PRESSURE	CRANE WEIGHT WITHOUT STABILIZERS	OIL TANK CAPACITY	OIL FLOW	DIMENSIONS
	tm	m	°	s/180°	°	bar	kg	l	l/min	mm B x h x S
HB700 E2	69,8	12,1	420	45	4	280	6350	280	80	2530x2450x1950
HB700 E4	-	16,0	420	45	4	280	7000	280	80	2530x2450x1950
HB700 E6	-	20,2	420	45	4	280	7600	280	80	2530x2450x2110
HB700 E8	-	24,1	420	45	4	280	8150	280	80	2530x2505x2135
HB700 E10	-	28,7	420	45	4	280	8550	280	80	2530x2635x2135



HB-R

HB 330R

HB 350R

HB 430R

HB 450R

HB 600R

HB 660R

Large, user-friendly articulated cranes

HB 330R



HB330R E2

kg	31800	15900*	7880**	7450	5390	4140	3130	2450	1900	
m	1,00	2,00	4,03	4,28	5,88	7,63	9,58	11,53	13,53	

HB330R E3

kg	31400	15700*	7710**	7150	5140	3920	3130	2450	1900	1400
m	1,00	2,00	4,03	4,38	5,98	7,73	9,58	11,53	13,53	15,53

HB330R E4

kg	31000	15500*	7550**	6900	4920	3720	2950	2450	1900	1400	1080
m	1,00	2,00	4,03	4,45	6,08	7,83	9,68	11,53	13,53	15,53	17,53

*) Theoretical lifting capacity
 **) Fixed hook capacity

CE	<input checked="" type="checkbox"/>
NO CE	<input checked="" type="checkbox"/>
MANUAL	<input checked="" type="checkbox"/>
RADIO	<input checked="" type="checkbox"/>

MODELS	LIFTING MOMENT	MAX VERTICAL REACH (HYDR)	SLEWING ANGLE	SLEWING TIME	MAX WORKING HEEL	WORKING PRESSURE	CRANE WEIGHT WITHOUT STABILIZERS	OIL TANK CAPACITY	OIL FLOW	DIMENSIONS
	tm	m	°	s/180°	°	bar	kg	l	l/min	mm B x h x S
HB330R E2	31,8	11,6	380	20	4	290	3145	160	50	2550x2490x1175
HB330R E3	-	13,5	380	20	4	290	3370	160	50	2550x2490x1175
HB330R E4	-	15,4	380	20	4	290	3580	160	50	2550x2490x1175

HB 350R

LCS

HB350R E2

kg	32800	16400*	8100**	7680	5580	4300	3270	2560	2010
m	1,00	2,00	4,03	4,28	5,88	7,63	9,58	11,53	13,53

HB350R E3

kg	32200	16100*	7930**	7350	5300	4070	3270	2560	2010	1495
m	1,00	2,00	4,03	4,38	5,98	7,73	9,58	11,53	13,53	15,53

HB350R E4

kg	31600	15800*	7790**	7100	5060	3850	3060	2560	2010	1495	1160
m	1,00	2,00	4,03	4,45	6,08	7,83	9,68	11,53	13,53	15,53	17,53

*) Theoretical lifting capacity

**) Fixed hook capacity

CE	<input type="checkbox"/>
NO CE	<input checked="" type="checkbox"/>
MANUAL	<input checked="" type="checkbox"/>
RADIO	<input checked="" type="checkbox"/>

MODELS	LIFTING MOMENT	MAX VERTICAL REACH (HYDR)	SLEWING ANGLE	SLEWING TIME	MAX WORKING HEEL	WORKING PRESSURE	CRANE WEIGHT WITHOUT STABILIZERS	OIL TANK CAPACITY	OIL FLOW	DIMENSIONS
	tm	m	°	s/180°	°	bar	kg	l	l/min	
HB350R E2	32,8	11,6	380	20	4	300	3165	160	50	2550x2490x1175
HB350R E3	-	13,5	380	20	4	300	3390	160	50	2550x2490x1175
HB350R E4	-	15,4	380	20	4	300	3600	160	50	2550x2490x1175

HB 430R



HB430R E2

kg	43560*	21780*	10250	7400	5650	4480	3550	2500
m	1,00	2,00	4,25	5,85	7,60	9,55	11,5	13,5

HB430R E3

kg	42800*	21400*	9850	7050	5350	4300	3550	2500	1800
m	1,00	2,00	4,35	5,95	7,70	9,55	11,5	13,5	15,5

HB430R E4

kg	42300*	21150*	9500	6700	5140	4080	3400	2500	1800	1250
m	1,00	2,00	4,45	6,05	7,80	9,65	11,5	13,5	15,5	17,5

HB430R E6

kg	41140*	20570*	9350	6550	5100	3900	3100	2600	2150	1000
m	1,00	2,00	4,40	5,95	7,65	9,50	11,3	13,15	15,0	17,0

*) Theoretical lifting capacity

CE	<input checked="" type="checkbox"/>
NO CE	<input checked="" type="checkbox"/>
MANUAL	<input checked="" type="checkbox"/>
RADIO	<input checked="" type="checkbox"/>

MODELS	LIFTING MOMENT	MAX VERTICAL REACH (HYDR)	SLEWING ANGLE	SLEWING TIME	MAX WORKING HEEL	WORKING PRESSURE	CRANE WEIGHT WITHOUT STABILIZERS	OIL TANK CAPACITY	OIL FLOW	DIMENSIONS
	tm	m	°	s/180°	°	bar	kg	l	l/min	mm B x h x S
HB430R E2	43,6	11,64	385	20	4	250	3835	250	50	2550x2495x1280
HB430R E3	-	13,55	385	20	4	250	4075	250	50	2550x2495x1280
HB430R E4	-	15,46	385	20	4	250	4280	250	50	2550x2495x1280
HB430R E6	-	19,02	385	20	4	270	4690	250	50	2590x2495x1390

HB 450R

LCS

HB450R E2

kg	45480*	22740*	10700	7750	5950	4480	3550	2500
m	1,00	2,00	4,25	5,85	7,60	9,55	11,5	13,5

HB450R E3

kg	44800*	22400*	10300	7400	5600	4480	3550	2500	1800
m	1,00	2,00	4,35	5,95	7,70	9,55	11,5	13,5	15,5

HB450R E4

kg	44640*	22320*	10030	7200	5400	4270	3550	2500	1800	1250
m	1,00	2,00	4,45	6,05	7,80	9,65	11,5	13,5	15,5	17,5

HB450R E6

kg	43560*	21780*	9900	6900	5400	4100	3250	2750	2250	1000
m	1,00	2,00	4,40	5,95	7,65	9,50	11,3	13,15	15,0	17,0

*) Theoretical lifting capacity

CE	<input type="checkbox"/>
NO CE	<input checked="" type="checkbox"/>
MANUAL	<input checked="" type="checkbox"/>
RADIO	<input checked="" type="checkbox"/>

MODELS	LIFTING MOMENT	MAX VERTICAL REACH (HYDR)	SLEWING ANGLE	SLEWING TIME	MAX WORKING HEEL	WORKING PRESSURE	CRANE WEIGHT WITHOUT STABILIZERS	OIL TANK CAPACITY	OIL FLOW	DIMENSIONS
	tm	m	°	s/180°	°	bar	kg	l	l/min	
HB450R E2	45,5	11,64	385	20	4	270	3885	250	50	2550x2495x1280
HB450R E3	-	13,55	385	20	4	270	4125	250	50	2550x2495x1280
HB450R E4	-	15,46	385	20	4	270	4330	250	50	2550x2495x1280
HB450R E6	-	19,02	385	20	4	270	4690	250	50	2590x2495x1390

HB 600R

LAS



HB600R E4

kg	57400*	28700	12900	9000	6780	5360	4470	3300	2850	2200
m	1,00	2,00	4,45	6,3	8,15	10,15	12,15	14,3	16,4	18,6

HB600R E6

kg	55000*	27500	12200	8340	6200	4820	3940	3300	2850	2200	1680
m	1,00	2,00	4,5	6,35	8,2	10,2	12,2	14,3	16,4	18,6	20,9

HB600R E6 J4

kg												1410	1270	1050	770	610	470
m												19,30	21,00	22,75	24,50	26,30	28,22

CE	<input checked="" type="checkbox"/>
NO CE	<input checked="" type="checkbox"/>
MANUAL	<input checked="" type="checkbox"/>
RADIO	<input checked="" type="checkbox"/>

*) Theoretical lifting capacity

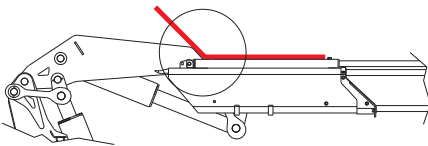

Second boom with negative angle in order to simplify operations in difficult access conditions

MODELS	LIFTING MOMENT	MAX VERTICAL REACH (HYDR)	SLEWING ANGLE	SLEWING TIME	MAX WORKING HEEL	WORKING PRESSURE	CRANE WEIGHT WITHOUT STABILIZERS	OIL TANK CAPACITY	OIL FLOW	DIMENSIONS
	tm	m	°	s/180°	°	bar	kg	l	l/min	
HB600R E4	57,4	16,0	428	18	4	290	5100	250	70	2550x2420x1465
HB600R E6	-	20,2	428	18	4	290	5600	250	70	2550x2420x1465
HB600R E6J4	-	20,6	428	18	4	285	6470	250	70	2560x2870x1568

HB 660R

LCS
LAS



HB660R E4

kg	58800*	29400*	13220	9300	7070	5640	4750	3540	3085	2400
m	1,00	2,00	4,45	6,3	8,15	10,15	12,15	14,3	16,4	18,6

HB660R E6

kg	56200*	28100*	12500	8620	5080	4185	3540	3540	3085	2400	1920
m	1,00	2,00	4,5	6,35	8,2	10,2	12,2	14,3	16,4	18,6	20,9

CE	<input type="checkbox"/>
NO CE	<input checked="" type="checkbox"/>
MANUAL	<input checked="" type="checkbox"/>
RADIO	<input checked="" type="checkbox"/>

*) Theoretical lifting capacity

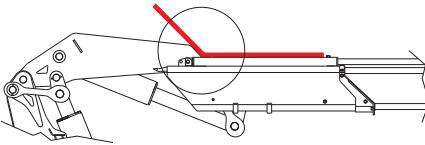

Second boom with negative angle in order to simplify operations in difficult access conditions

MODELS	LIFTING MOMENT	MAX VERTICAL REACH (HYDR)	SLEWING ANGLE	SLEWING TIME	MAX WORKING HEEL	WORKING PRESSURE	CRANE WEIGHT WITHOUT STABILIZERS	OIL TANK CAPACITY	OIL FLOW	DIMENSIONS
	tm	m	°	s/180°	°	bar	kg	l	l/min	mm B x h x S
HB660R E4	58,8	16,3	428	18	4	300	5150	250	70	2550x2420x1465
HB660R E6	-	20,5	428	18	4	300	5650	250	70	2550x2420x1465



TRAVE LINE

HYT 135

HYT 165

HYT 455

In-Line trave, user-friendly articulated cranes

HYT 135



**HYT 135
E3**

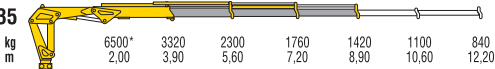

*) Theoretical lifting capacity

CE	<input type="checkbox"/>
NO CE	<input checked="" type="checkbox"/>
MANUAL	<input checked="" type="checkbox"/>
RADIO	<input checked="" type="checkbox"/>

MODELS	LIFTING MOMENT	MAX VERTICAL REACH (HYDR)	SLEWING ANGLE	SLEWING TIME	MAX WORKING HEEL	WORKING PRESSURE	CRANE WEIGHT WITH STABILIZERS	OIL TANK CAPACITY	OIL FLOW	DIMENSIONS
	tm	m	°	s/180°	°	bar	kg	l	l/min	mm B x h x S
HYT 135 E3	13	12,10	380	-	-	195	1950	80	35	2524x2317x802

HYT 165



HYT 165 E3

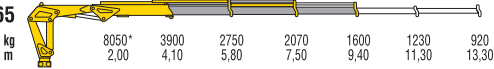

*) Theoretical lifting capacity

CE	<input type="checkbox"/>
NO CE	<input checked="" type="checkbox"/>
MANUAL	<input checked="" type="checkbox"/>
RADIO	<input checked="" type="checkbox"/>

MODELS	LIFTING MOMENT	MAX VERTICAL REACH (HYDR)	SLEWING ANGLE	SLEWING TIME	MAX WORKING HEEL	WORKING PRESSURE	CRANE WEIGHT WITH STABILIZERS	OIL TANK CAPACITY	OIL FLOW	DIMENSIONS
	tm	m	°	s/180°	°	bar	kg	l	l/min	mm B x h x S
HYT 165 E3	16,1	12,50	380	-	-	250	2390	80	35	2564x2307x783

HYT 455

EES
SDS



HYT 445
E4

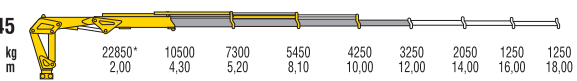

*) Theoretical lifting capacity

CE	<input type="checkbox"/>
NO CE	<input checked="" type="checkbox"/>
MANUAL	<input checked="" type="checkbox"/>
RADIO	<input checked="" type="checkbox"/>

HYT 455



EES Extra Extension Speed
SDS Smooth Descent System

MODELS	LIFTING MOMENT	MAX VERTICAL REACH (HYDR)	SLEWING ANGLE	SLEWING TIME	MAX WORKING HEEL	WORKING PRESSURE	CRANE WEIGHT WITH STABILIZERS	OIL TANK CAPACITY	OIL FLOW	DIMENSIONS
	tm	m	°	s/180°	°	bar	kg	l	l/min	mm B x h x S
HYT 455 E4	45,7	15,75	360	-	-	270	4910	140	50	2600x2540x975

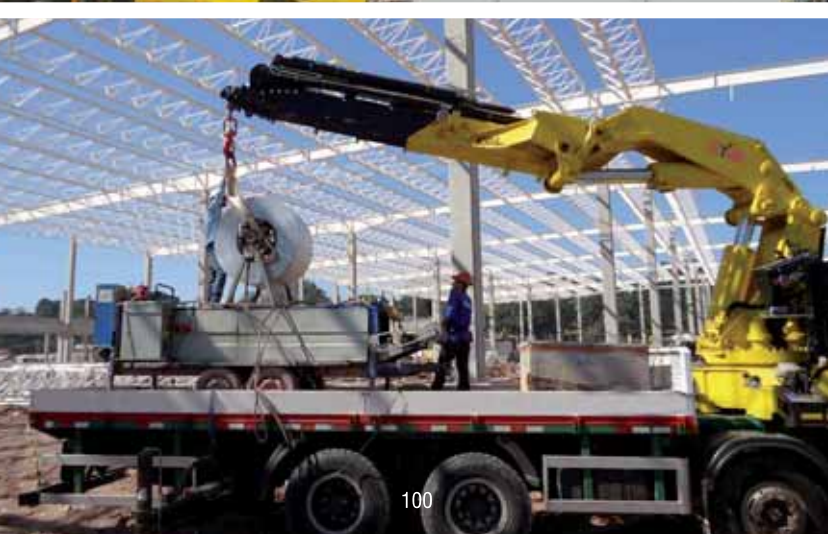

HC

HC 91	HC 243K
HC 91K	HC 261 
HC 103 	HC 265e 
HC 111	HC 291
HC 111K	HC 331
HC 125 	HC 361
HC 131	HC 401
HC 131K	HC 401K 
HC 153 	HC 405e 
HC 161	HC 441 
HC 161K	HC 445e 
HC 183 	HC 501 
HC 213	HC 601e 
HC 213K	HC 661e 
HC 231	HC 801 
HC 243	

Best in class articulated cranes.
 For heavy users who require ultimate precision and lifting capacity.
 Packed with innovation, the HC line offers a wide range of accessories besides the already standard incorporated features

HC 91



EES
SDS
LAS

HC91 E1

kg	8370*	3960*	3080**	2000	1400
m	1,00	2,00	2,63	4,17	5,98

HC91 E2

kg	8070*	3830*	2980**	1935	1330	1015	720	515
m	1,00	2,00	2,63	4,17	5,98	7,79	9,82	11,85

HC91 E3

kg	7630*	3610*	2820**	1795	1210	910	720	515	355
m	1,00	2,00	2,63	4,25	6,06	7,87	9,82	11,85	14,00

HC91 E4

kg	7380*	3500*	2720**	1705	1130	830	640	515	355	280
m	1,00	2,00	2,63	4,33	6,14	7,95	9,90	11,85	14,00	16,18

HC91 E5

kg	7040*	3250*	2600**	1600	1040	710	535	430	355	280
m	1,00	2,00	2,63	4,40	6,21	8,02	9,97	11,92	14,00	16,18

- CE**
- NO CE**
- MANUAL**
- RADIO**

*) Theoretical lifting capacity *) Max lifting capacity
**) Fixed hook capacity

HC 91



EES Extra Extension Speed
SDS Smooth Descent System
LAS Liftrod Articulating System

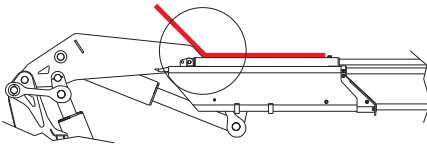

Second boom with negative angle in order to simplify operations in difficult access conditions

MODELS	LIFTING MOMENT	MAX VERTICAL REACH (HYDR)	SLEWING ANGLE	SLEWING TIME	MAX WORKING HEEL	WORKING PRESSURE	CRANE WEIGHT WITHOUT STABILIZERS	OIL TANK CAPACITY	OIL FLOW	DIMENSIONS
	tm	m	°	s/180°	°	bar	kg	l	l/min	mm B x h x S
HC91 E1	8,4	9,3	425	12	4	315	1100	75	40	2290X2085X840
HC91 E2	-	10,9	425	12	4	315	1195	75	40	2290X2085X840
HC91 E3	-	13,1	425	12	4	315	1285	75	40	2290X2085X840
HC91 E4	-	15,1	425	12	4	315	1365	75	40	2290X2085X840
HC91 E5	-	17,3	425	12	4	315	1445	75	40	2290X2085X885

HC 91 K

EES
SDS
LAS



HC91K E2

kg	8350*	3970*	2390	1700	1210	
m	1,00	2,00	3,47	4,91	6,72	

HC91K E3

kg	8040*	3830*	2265	1555	1115	850	
m	1,00	2,00	3,55	5,00	6,80	8,75	

*) Theoretical lifting capacity •)Max lifting capacity

CE	<input checked="" type="checkbox"/>
NO CE	<input checked="" type="checkbox"/>
MANUAL	<input checked="" type="checkbox"/>
RADIO	<input checked="" type="checkbox"/>

HC 91 K



EES Extra Extension Speed
SDS Smooth Descent System
LAS Liftrod Articulating System

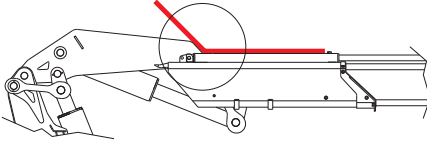

Second boom with negative angle in order to simplify operations in difficult access conditions

MODELS	LIFTING MOMENT	MAX VERTICAL REACH (HYDR)	SLEWING ANGLE	SLEWING TIME	MAX WORKING HEEL	WORKING PRESSURE	CRANE WEIGHT WITHOUT STABILIZERS	OIL TANK CAPACITY	OIL FLOW	DIMENSIONS
	tm	m	°	s/180°	°	bar	kg	l	l/min	mm B x h x S
HC91K E2	8,3	10,1	425	12	4	315	1170	75	40	2285x2085x840
HC91K E3	-	12,2	425	12	4	315	1260	75	40	2285x2085x840

HC 103



- EES**
- SDS**
- P-LCS**
- LAS**

HC103 E1

kg	9510*	4480*	3480**	2260	1590
m	1,00	2,00	2,63	4,17	5,98

HC103 E2

kg	9130*	4340*	3380**	2190	1520	1160	820	605
m	1,00	2,00	2,63	4,17	5,98	7,79	9,82	11,85

HC103 E3

kg	8650*	4100*	3200**	2035	1375	1030	815	610	430
m	1,00	2,00	2,63	4,25	6,06	7,87	9,82	11,85	14,00

HC103 E4

kg	8160*	3830*	3010**	1885	1245	910	705	580	425	355
m	1,00	2,00	2,63	4,33	6,14	7,95	9,90	11,85	14,00	16,18

HC103 E5

kg	7770*	3660*	2860**	1765	1150	825	625	500	415	330
m	1,00	2,0	2,63	4,40	6,21	8,02	9,97	11,92	14,00	16,18

CE	<input checked="" type="checkbox"/>
NO CE	<input checked="" type="checkbox"/>
MANUAL	<input type="checkbox"/>
RADIO	<input checked="" type="checkbox"/>

*) Theoretical lifting capacity •) Max lifting capacity
 **) Fixed hook capacity

HC 103 X



- EES** Extra Extension Speed
- SDS** Smooth Descent System
- P-LCS** Proportional Lift Control System
- LAS** Liftrod Articulating System

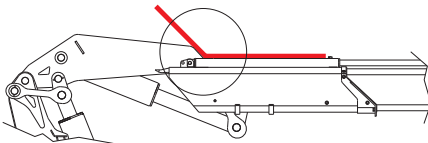

Second boom with negative angle in order to simplify operations in difficult access conditions

MODELS	LIFTING MOMENT	MAX VERTICAL REACH (HYDR)	SLEWING ANGLE	SLEWING TIME	MAX WORKING HEEL	WORKING PRESSURE	CRANE WEIGHT WITHOUT STABILIZERS	OIL TANK CAPACITY	OIL FLOW	DIMENSIONS
	tm	m	°	s/180°	°	bar	kg	l	l/min	
HC103 E1	9,5	9,3	425	12	4	350	1105	75	40	2290X2085X840
HC103 E2	-	10,9	425	12	4	350	1195	75	40	2290X2085X840
HC103 E3	-	13,1	425	12	4	347	1285	75	40	2290X2085X840
HC103 E4	-	15,1	425	12	4	340	1370	75	40	2290X2085X840
HC103 E5	-	17,3	425	12	4	336	1445	75	40	2290X2085X885

HC 111

EES
SDS
LAS



HC111 E1

kg	10220*	4860*	3780**	2450	1705
m	1,00	2,00	2,63	4,17	5,98

HC111 E2

kg	9880*	4690*	3650**	2370	1620	1225	880	640
m	1,00	2,00	2,63	4,17	5,98	7,79	9,82	11,85

HC111 E3

kg	9440*	4490*	3490**	2220	1490	1110	880	640	460
m	1,00	2,00	2,63	4,25	6,06	7,87	9,82	11,85	14,00

HC111 E4

kg	9050*	4290*	3340**	2090	1375	1005	780	640	460	370
m	1,00	2,00	2,63	4,33	6,14	7,95	9,90	11,85	14,00	16,19

HC111 E5

kg	8760*	4150*	3230**	1990	1290	925	695	560	465	370
m	1,00	2,00	2,63	4,40	6,21	8,02	9,97	11,92	14,00	16,19

HC111 E3J2

kg						405	360	320	260
m						12,63	14,01	15,49	17,05

CE	<input checked="" type="checkbox"/>
NO CE	<input checked="" type="checkbox"/>
MANUAL	<input checked="" type="checkbox"/>
RADIO	<input checked="" type="checkbox"/>

*) Theoretical lifting capacity •) Max lifting capacity
**) Fixed hook capacity

HC 111



EES Extra Extension Speed
SDS Smooth Descent System
LAS Liftrod Articulating System

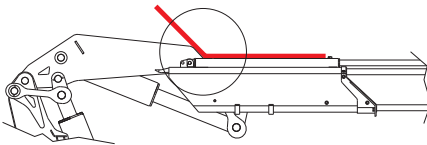

Second boom with negative angle in order to simplify operations in difficult access conditions

MODELS	LIFTING MOMENT	MAX VERTICAL REACH (HYDR)	SLEWING ANGLE	SLEWING TIME	MAX WORKING HEEL	WORKING PRESSURE	CRANE WEIGHT WITHOUT STABILIZERS	OIL TANK CAPACITY	OIL FLOW	DIMENSIONS
	tm	m	°	s/180°	°	bar	kg	l	l/min	mm B x h x S
HC111 E1	10,2	9,5	425	12	4	315	1155	75	40	2280X2110X840
HC111 E2	-	11,3	425	12	4	320	1265	75	40	2280X2110X840
HC111 E3	-	13,3	425	12	4	320	1370	75	40	2280X2110X840
HC111 E4	-	15,4	425	12	4	320	1465	75	40	2280X2110X840
HC111 E5	-	17,5	425	12	4	320	1555	75	40	2280X2110X885
HC111 E3J2	-	18,8	425	12	3	315	1710	75	40	2280X2420X890

HC 111K



HC111K E2

kg	9590*	4580*	2665	1875	1370
m	1,00	2,00	3,60	5,04	6,85

HC111K E3

kg	9290*	4430*	2530	1760	1265	975
m	1,00	2,00	3,67	5,11	6,92	8,87

CE	<input checked="" type="checkbox"/>
NO CE	<input checked="" type="checkbox"/>
MANUAL	<input checked="" type="checkbox"/>
RADIO	<input checked="" type="checkbox"/>

*) Theoretical lifting capacity *)Max lifting capacity

HC 111K



EES Extra Extension Speed
SDS Smooth Descent System
LAS Liftrod Articulating System

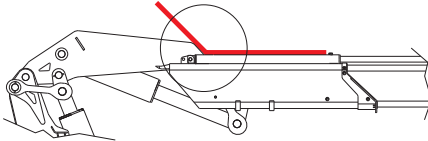

Second boom with negative angle in order to simplify operations in difficult access conditions

MODELS	LIFTING MOMENT	MAX VERTICAL REACH (HYDR)	SLEWING ANGLE	SLEWING TIME	MAX WORKING HEEL	WORKING PRESSURE	CRANE WEIGHT WITHOUT STABILIZERS	OIL TANK CAPACITY	OIL FLOW	DIMENSIONS
	tm	m	°	s/180°	°	bar	kg	l	l/min	mm B x h x S
HC111K E2	9,5	10,3	425	12	4	300	1230	75	40	2305x2110x840
HC111K E3	-	12,4	425	12	4	300	1340	75	40	2305x2110x840

HC 125



- EES**
- SDS**
- P-LCS**
- LAS**

- CE**
- NO CE**
- MANUAL**
- RADIO**

HC125 E1

kg	11510*	5400*	4260**	2760	1920
m	1,00	2,00	2,63	4,17	5,98

HC125 E2

kg	11180*	5310*	4130**	2680	1830	1395	995	715
m	1,00	2,00	2,63	4,17	5,98	7,79	9,82	11,85

HC125 E3

kg	10580*	5010*	3910**	2490	1680	1260	995	715	525
m	1,00	2,00	2,63	4,25	6,06	7,87	9,82	11,85	14,00

HC125 E4

kg	9940*	4700*	3670**	2295	1525	1120	870	715	525	430
m	1,00	2,00	2,63	4,33	6,14	7,95	9,90	11,85	14,00	16,19

HC125 E5

kg	9570*	4530*	3530**	2175	1425	1030	780	630	525	430
m	1,00	2,00	2,63	4,40	6,21	8,02	9,97	11,92	14,00	16,19

HC125 E3J2

kg						480	420	380	310
m						12,63	14,01	15,49	17,05

*) Theoretical lifting capacity *) Max lifting capacity
 **) Fixed hook capacity

HC 125



- EES Extra Extension Speed**
- SDS Smooth Descent System**
- P-LCS Proportional Lift Control System**
- LAS Liftrod Articulating System**

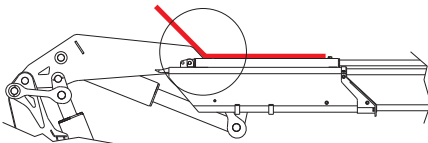

Second boom with negative angle in order to simplify operations in difficult access conditions

MODELS	LIFTING MOMENT	MAX VERTICAL REACH (HYDR)	SLEWING ANGLE	SLEWING TIME	MAX WORKING HEEL	WORKING PRESSURE	CRANE WEIGHT WITHOUT STABILIZERS	OIL TANK CAPACITY	OIL FLOW	DIMENSIONS
	tm	m	°	s/180°	°	bar	kg	l	l/min	
HC125 E1	11,5	9,5	425	12	4	350	1155	75	40	2305X2110X840
HC125 E2	-	11,3	425	12	4	355	1265	75	40	2305X2110X840
HC125 E3	-	13,3	425	12	4	350	1370	75	40	2305X2110X840
HC125 E4	-	15,4	425	12	4	345	1465	75	40	2305X2110X840
HC125 E5	-	17,5	425	12	4	345	1555	75	40	2305X2110X885
HC125 E3J2	-	18,8	425	12	3	350	1710	75	40	2280X2420X890

HC 131

EES
SDS
LAS



HC131 E2

kg	12010*	5800*	4120**	2595	1770	1345	975	720	525
m	1,00	2,00	2,87	4,63	6,58	8,53	10,91	12,96	15,11

CE	<input checked="" type="checkbox"/>
NO CE	<input checked="" type="checkbox"/>
MANUAL	<input checked="" type="checkbox"/>
RADIO	<input checked="" type="checkbox"/>

HC131 E3

kg	11610*	5600*	3980**	2465	1650	1230	975	720	525	375
m	1,00	2,00	2,87	4,71	6,66	8,61	10,66	12,96	15,11	17,26

HC131 E4

kg	11230*	5400*	3850**	2340	1540	1125	870	720	525	375	280
m	1,00	2,00	2,87	4,80	6,75	8,70	10,75	12,80	15,11	17,26	19,36

HC131 E5

kg	10860*	5220*	3720**	2225	1435	1025	775	625	525	375	280
m	1,00	2,00	2,87	4,88	6,83	8,78	10,83	12,88	15,03	17,26	19,36

HC131 E6

kg	10520*	5060*	3600**	2120	1345	935	690	535	435	375	280
m	1,00	2,00	2,87	4,96	6,91	8,86	10,91	12,96	15,11	17,26	19,36

HC131 E3J2

kg							430	380	340	260
m							13,35	14,75	16,22	17,80

HC131 E4J2

kg							250	220	200	130
m							15,50	16,85	18,35	19,89

*) Theoretical lifting capacity °) Max lifting capacity
**) Fixed hook capacity

HC 131



EES Extra Extension Speed
SDS Smooth Descent System
LAS Liftrod Articulating System

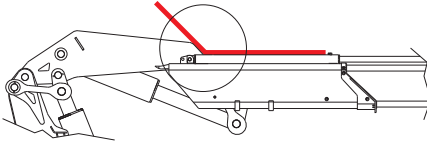

Second boom with negative angle in order to simplify operations in difficult access conditions

MODELS	LIFTING MOMENT	MAX VERTICAL REACH (HYDR)	SLEWING ANGLE	SLEWING TIME	MAX WORKING HEEL	WORKING PRESSURE	CRANE WEIGHT WITHOUT STABILIZERS	OIL TANK CAPACITY	OIL FLOW	DIMENSIONS
	tm	m	°	s/180°	°	bar	kg	l	l/min	
HC131 E2	12,0	12,2	425	12	4	290	1610	130	60	2450x2330x825
HC131 E3	-	14,4	425	12	4	290	1725	130	60	2450x2330x825
HC131 E4	-	16,5	425	12	4	290	1830	130	60	2450x2330x825
HC131 E5	-	18,8	425	12	4	290	1930	130	60	2450x2330x895
HC131 E6	-	21,0	425	12	4	290	2020	130	60	2450x2330x895
HC131 E3J2	-	19,8	425	12	3	290	2125	130	60	2450x2450x940
HC131 E4J2	-	22,0	425	12	3	290	2230	130	60	2450x2500x940

HC 131K

EES

SDS

LAS



HC131K E2

	12520*	5400*	3210	2310	1700
kg	1,00	2,23	3,90	5,30	7,10
m					

HC131K E3

	12170*	5400*	3080	2200	1600	1250
kg	1,00	2,18	3,95	5,38	7,20	9,15
m						

*) Theoretical lifting capacity

*) Max lifting capacity

CE	<input checked="" type="checkbox"/>
NO CE	<input checked="" type="checkbox"/>
MANUAL	<input checked="" type="checkbox"/>
RADIO	<input checked="" type="checkbox"/>

HC 131K



EES Extra Extension Speed
SDS Smooth Descent System
LAS Liftrod Articulating System

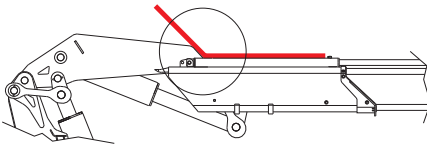

Second boom with negative angle in order to simplify operations in difficult access conditions

MODELS	LIFTING MOMENT	MAX VERTICAL REACH (HYDR)	SLEWING ANGLE	SLEWING TIME	MAX WORKING HEEL	WORKING PRESSURE	CRANE WEIGHT WITHOUT STABILIZERS	OIL TANK CAPACITY	OIL FLOW	DIMENSIONS
	tm	m	°	s/180°	°	bar	kg	l	l/min	mm B x h x S
HC131K E2	12,5	10,9	425	12	4	290	1525	130	40	2455x2330x825
HC131K E3	-	12,9	425	12	4	290	1625	130	40	2455x2330x825

HC 153

- EES**
- SDS**
- P-LCS**
- LAS**



HC153 E2

kg	13940*	6730*	4120*	3010	2060	1570	1160	870	655
m	1,00	2,00	2,87	4,63	6,58	8,53	10,91	12,96	15,11

- CE**
- NO CE**
- MANUAL**
- RADIO**

HC153 E3

kg	13520*	6510*	3980*	2870	1940	1455	1160	870	655	485
m	1,00	2,00	2,87	4,71	6,66	8,61	10,66	12,96	15,11	17,26

HC153 E4

kg	13150*	6320*	3850*	2740	1825	1345	1050	870	655	485	395
m	1,00	2,00	2,87	4,80	6,75	8,70	10,75	12,80	15,11	17,26	19,36

HC153 E5

kg	12760*	6120*	3720*	2615	1720	1245	955	775	655	485	395
m	1,00	2,00	2,87	4,88	6,83	8,78	10,83	12,88	15,03	17,26	19,36

HC153 E6

kg	12420*	5940*	3600*	2505	1625	1155	865	685	565	485	395
m	1,00	2,00	2,87	4,96	6,91	8,86	10,91	12,96	15,11	17,26	19,36

HC153 E3J2

kg								615	560	500	350
m								13,35	14,75	16,22	17,80

HC153 E4J2

kg									420	380	340	200
m									15,50	16,85	18,35	19,89

*) Theoretical lifting capacity *) Max lifting capacity
 **) Fixed hook capacity

HC 153



EES Extra Extension Speed
SDS Smooth Descent System
P-LCS Proportional Lift Control System
LAS Liftrod Articulating System

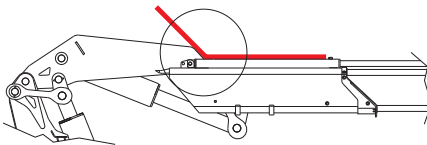

Second boom with negative angle in order to simplify operations in difficult access conditions

MODELS	LIFTING MOMENT	MAX VERTICAL REACH (HYDR)	SLEWING ANGLE	SLEWING TIME	MAX WORKING HEEL	WORKING PRESSURE	CRANE WEIGHT WITHOUT STABILIZERS	OIL TANK CAPACITY	OIL FLOW	DIMENSIONS
	tm	m	°	s/180°	°	bar	kg	l	l/min	mm B x h x S
HC153 E2	13,9	12,2	425	12	4	325	1610	130	60	2450x2330x825
HC153 E3	-	14,4	425	12	4	325	1725	130	60	2450x2330x825
HC153 E4	-	16,5	425	12	4	325	1830	130	60	2450x2330x825
HC153 E5	-	18,8	425	12	4	325	1930	130	60	2450x2330x895
HC153 E6	-	21,0	425	12	4	325	2020	130	60	2450x2330x895
HC153 E3J2	-	19,8	425	12	3	325	2125	130	60	2450x2450x940
HC153 E4J2	-	22,0	425	12	3	325	2230	130	60	2450x2500x940

HC 161



HC161 E2

kg	15330*	7400*	5270**	3310	2265	1725	1270	950	710
m	1,00	2,00	2,86	4,63	6,58	8,53	10,91	12,96	15,11

CE	<input checked="" type="checkbox"/>
NO CE	<input checked="" type="checkbox"/>
MANUAL	<input checked="" type="checkbox"/>
RADIO	<input checked="" type="checkbox"/>

HC161 E3

kg	14860*	7170*	5110**	3155	2125	1590	1270	950	710	530
m	1,00	2,00	2,86	4,71	6,66	8,61	10,66	12,96	15,11	17,26

HC161 E4

kg	14450*	6960*	4970**	3010	2000	1470	1150	950	710	530	400
m	1,00	2,00	2,86	4,80	6,75	8,70	10,75	12,80	15,11	17,26	19,36

HC161 E5

kg	14030*	6760*	4820**	2875	1885	1360	1040	845	710	530	400
m	1,00	2,00	2,86	4,88	6,83	8,78	10,83	12,88	15,03	17,26	19,36

HC161 E6

kg	13640*	6570*	4690**	2750	1780	1260	945	745	615	530	400
m	1,00	2,00	2,86	4,96	6,91	8,86	10,91	12,96	15,11	17,26	19,36

HC161 E3J3

kg							640	545	485	425	320	270
m							13,60	15,20	16,70	18,30	19,90	21,70

HC161 E4J2

kg							380	330	290	265	215	175
m							15,73	17,29	18,85	20,41	22,11	23,81

*) Theoretical lifting capacity *) Max lifting capacity
 **) Fixed hook capacity

HC 161



EES Extra Extension Speed
SDS Smooth Descent System
LAS Liftrod Articulating System

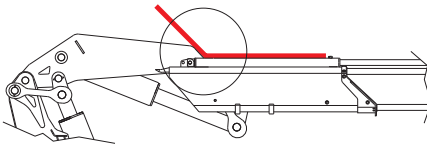

Second boom with negative angle in order to simplify operations in difficult access conditions

MODELS	LIFTING MOMENT	MAX VERTICAL REACH (HYDR)	SLEWING ANGLE	SLEWING TIME	MAX WORKING HEEL	WORKING PRESSURE	CRANE WEIGHT WITHOUT STABILIZERS	OIL TANK CAPACITY	OIL FLOW	DIMENSIONS
	tm	m	°	s/180°	°	bar	kg	l	l/min	mm B x h x S
HC161 E2	15,3	12,2	425	12	4	300	1740	130	60	2475x2330x825
HC161 E3	-	14,4	425	12	4	300	1870	130	60	2475x2330x825
HC161 E4	-	16,5	425	12	4	300	1990	130	60	2475x2330x825
HC161 E5	-	18,8	425	12	4	300	2100	130	60	2475x2330x905
HC161 E6	-	21,0	425	12	4	300	2195	130	60	2475x2330x905
HC161 E3J3	-	21,9	425	12	3	315	2360	130	60	2475x2615x957
HC161 E4J3	-	25,7	425	12	3	-	2490	130	60	2475x2640x950

HC 161K

EES
SDS
LAS



HC161K E2

kg	15440*	7480*	4010	2940	2115
m	1,00	2,00	3,85	5,18	7,13

HC161K E3

kg	15050*	7290*	3860	2805	1990	1530
m	1,00	2,00	3,90	5,23	7,18	9,23

*) Theoretical lifting capacity *)Max lifting capacity

CE	<input checked="" type="checkbox"/>
NO CE	<input checked="" type="checkbox"/>
MANUAL	<input checked="" type="checkbox"/>
RADIO	<input checked="" type="checkbox"/>

HC 161K



EES Extra Extension Speed

SDS Smooth Descent System

LAS Liftrod Articulating System

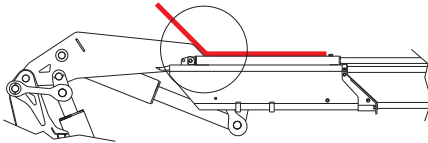

Second boom with negative angle in order to simplify operations in difficult access conditions

MODELS	LIFTING MOMENT	MAX VERTICAL REACH (HYDR)	SLEWING ANGLE	SLEWING TIME	MAX WORKING HEEL	WORKING PRESSURE	CRANE WEIGHT WITHOUT STABILIZERS	OIL TANK CAPACITY	OIL FLOW	DIMENSIONS
	tm	m	°	s/180°	°	bar	kg	l	l/min	mm B x h x S
HC161K E2	15,4	10,9	425	12	4	300	1630	130	60	2470x2330x825
HC161K E3	-	12,9	425	12	4	300	1755	130	60	2470x2330x825

HC 183

EES
SDS
P-LCS
LAS



HC183 E2

kg	17290*	8000*	5950**	3735	2560	1955	1455	1105	845
m	1,00	2,00	2,86	4,63	6,58	8,53	10,91	12,96	15,11

CE	<input checked="" type="checkbox"/>
NO CE	<input checked="" type="checkbox"/>
MANUAL	<input checked="" type="checkbox"/>
RADIO	<input checked="" type="checkbox"/>

HC183 E3

kg	16810*	8000*	5780**	3570	2420	1820	1455	1105	845	645
m	1,00	2,00	2,86	4,71	6,66	8,61	10,66	12,96	15,11	17,26

HC183 E4

kg	16390*	7900*	5640**	3415	2290	1700	1335	1105	845	645	510
m	1,00	2,00	2,86	4,80	6,75	8,70	10,75	12,80	15,11	17,26	19,36

HC183 E5

kg	15980*	7680*	5490**	3275	2170	1585	1225	995	845	645	510
m	1,00	2,00	2,86	4,88	6,83	8,78	10,83	12,88	15,03	17,26	19,36

HC183 E6

kg	15600*	7480*	5360**	3145	2065	1485	1125	900	745	645	510
m	1,00	2,00	2,86	4,96	6,91	8,86	10,91	12,96	15,11	17,26	19,36

HC183 E3J3

kg								730	645	575	505	400	340
m								13,60	15,20	16,70	18,30	19,90	21,70

HC183 E4J3

kg									440	380	340	300	250	200
m									15,73	17,29	18,85	20,41	22,11	23,81

*) Theoretical lifting capacity *) Max lifting capacity
**) Fixed hook capacity

HC 183



EES Extra Extension Speed
SDS Smooth Descent System
P-LCS Proportional Lift Control System
LAS Liftrod Articulating System

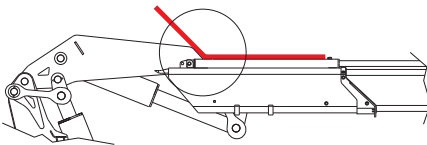

Second boom with negative angle in order to simplify operations in difficult access conditions

MODELS	LIFTING MOMENT	MAX VERTICAL REACH (HYDR)	SLEWING ANGLE	SLEWING TIME	MAX WORKING HEEL	WORKING PRESSURE	CRANE WEIGHT WITHOUT STABILIZERS	OIL TANK CAPACITY	OIL FLOW	DIMENSIONS
HC183 E2	17,3	12,2	425	12	4	330	1745	130	60	2475x2330x825
HC183 E3	-	14,4	425	12	4	330	1875	130	60	2475x2330x825
HC183 E4	-	16,5	425	12	4	330	1995	130	60	2475x2330x825
HC183 E5	-	18,8	425	12	4	330	2105	130	60	2475x2330x905
HC183 E6	-	21,0	425	12	4	330	2200	130	60	2475x2330x905
HC183 E3J3	-	21,9	425	12	3	340	2365	130	60	2475x2615x957
HC183 E4J3	-	25,7	425	12	3	340	2495	130	60	2475x2640x950

HC 213



EES Extra Extension Speed
SDS Smooth Descent System
LAS Liftrod Articulating System

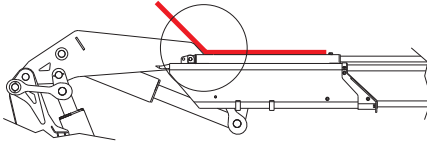

Second boom with negative angle in order to simplify operations in difficult access conditions

MODELS	LIFTING MOMENT	MAX VERTICAL REACH (HYDR)	SLEWING ANGLE	SLEWING TIME	MAX WORKING HEEL	WORKING PRESSURE	CRANE WEIGHT WITHOUT STABILIZERS	OIL TANK CAPACITY	OIL FLOW	DIMENSIONS
	tm	m	°	s/180°	°	bar	kg	l	l/min	mm B x h x S
HC213 E2	19,8	12,0	415	12	4	320	2210	130	70	2520x2300x930
HC213 E3	-	14,1	415	12	4	310	2360	130	70	2520x2300x930
HC213 E4	-	16,2	415	12	4	310	2510	130	70	2520x2300x930
HC213 E5	-	18,4	415	12	4	310	2630	130	70	2520x2300x930
HC213 E6	-	20,7	415	12	4	310	2725	130	70	2520x2300x930
HC213 E3J3	-	22,2	415	12	3	-	3020	130	70	2520x2695x1050
HC213 E4J3	-	23,8	415	12	3	-	3000	130	70	2520x2600x1050
HC213 E5J2	-	23,9	415	12	3	-	2905	130	70	2520x2550x1050

HC 213K

EES

SDS

LAS



HC213K E2

	18690*	8000*	5280	3815	2715
kg	1,00	2,09	3,54	4,87	6,82
m					

HC213K E3

	17680*	8000*	4870	3380	2455	1880
kg	1,00	2,04	3,63	4,96	6,91	8,96
m						

HC213K E4

	17320*	8000*	4680	3340	2320	1750	1410
kg	1,00	2,00	3,70	5,03	6,98	9,03	11,08
m							

*) Theoretical lifting capacity •) Max lifting capacity

CE	<input checked="" type="checkbox"/>
NO CE	<input checked="" type="checkbox"/>
MANUAL	<input checked="" type="checkbox"/>
RADIO	<input checked="" type="checkbox"/>

HC 213K



EES Extra Extension Speed
SDS Smooth Descent System
LAS Liftrod Articulating System

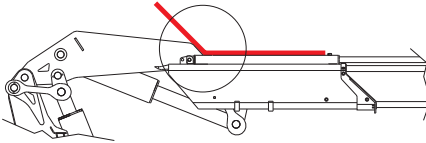

Second boom with negative angle in order to simplify operations in difficult access conditions

MODELS	LIFTING MOMENT	MAX VERTICAL REACH (HYDR)	SLEWING ANGLE	SLEWING TIME	MAX WORKING HEEL	WORKING PRESSURE	CRANE WEIGHT WITHOUT STABILIZERS	OIL TANK CAPACITY	OIL FLOW	DIMENSIONS
	tm	m	°	s/180°	°	bar	kg	l	l/min	mm B x h x S
HC213K E2	18,7	10,5	415	12	4	300	2085	130	70	2520x2300x870
HC213K E3	-	12,7	415	12	4	300	2220	130	70	2520x2300x870
HC213K E4	-	14,8	415	12	4	300	2340	130	70	2520x2300x870

HC 231

- EES**
- SDS**
- P-LCS**
- LAS**



HC231 E2

kg	21710*	8000**	8000*	4990	3380	2560
m	1,00	2,60	2,63	4,35	6,32	8,29

HC231 E3

kg	21160*	8000*	7940**	4865	3245	2420	1915	1460	1130	725
m	1,00	2,56	2,60	4,35	6,32	8,29	10,36	12,51	14,73	17,01

HC231 E4

kg	20710*	8000*	7760**	4675	3085	2270	1770	1460	1130	890	600
m	1,00	2,49	2,60	4,43	6,40	8,37	10,44	12,51	14,72	17,01	19,11

HC231 E5

kg	20270*	8000*	7600**	4495	2940	2140	1640	1340	1130	890	755
m	1,00	2,43	2,60	4,51	6,48	8,45	10,52	12,59	14,72	17,01	19,11

HC231 E6

kg	19990*	8000*	7480**	4345	2830	2040	1550	1280	1060	895	755
m	1,00	2,39	2,60	4,60	6,57	8,54	10,61	12,68	14,81	17,01	19,11

HC231 E3J3

kg							905	775	675	605	515	435
m							13,36	15,06	16,81	18,56	20,43	22,34

HC231 E4J3

kg									715	635	570	520	455	440
m									15,43	16,99	18,55	20,11	21,77	23,54

HC231 E5J2

kg											675	615	490	390
m											17,41	18,79	20,27	21,83

- CE**
- NO CE**
- MANUAL**
- RADIO**

*) Theoretical lifting capacity *) Max lifting capacity
 **) Fixed hook capacity

HC 231 X



- EES** Extra Extension Speed
- SDS** Smooth Descent System
- P-LCS** Proportional Lift Control System
- LAS** Liftrod Articulating System

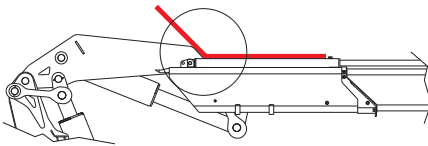

Second boom with negative angle in order to simplify operations in difficult access conditions

MODELS	LIFTING MOMENT	MAX VERTICAL REACH (HYDR)	SLEWING ANGLE	SLEWING TIME	MAX WORKING HEEL	WORKING PRESSURE	CRANE WEIGHT WITHOUT STABILIZERS	OIL TANK CAPACITY	OIL FLOW	DIMENSIONS mm B x h x S
	tm	m	°	s/180°	°	bar	kg	l	l/min	
HC231 E2	21,7	12,0	415	12	4	345	2210	130	70	2520x2300x930
HC231 E3	-	14,1	415	12	4	345	2360	130	70	2520x2300x930
HC231 E4	-	16,2	415	12	4	345	2510	130	70	2520x2300x930
HC231 E5	-	18,4	415	12	4	345	2630	130	70	2520x2300x930
HC231 E6	-	20,7	415	12	4	345	2725	130	70	2520x2300x930
HC231 E3J3	-	22,2	415	12	3	-	3020	130	70	2520x2695x1050
HC231 E4J3	-	23,8	415	12	3	-	3000	130	70	2520x2600x1050
HC231 E5J2	-	23,9	415	12	3	-	2905	130	70	2520x2550x1050

HC 243



EES Extra Extension Speed
SDS Smooth Descent System
LAS Liftrod Articulating System

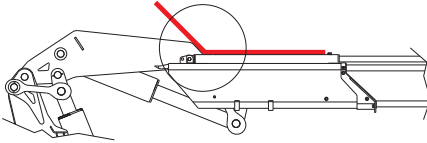

Second boom with negative angle in order to simplify operations in difficult access conditions

MODELS	LIFTING MOMENT	MAX VERTICAL REACH (HYDR)	SLEWING ANGLE	SLEWING TIME	MAX WORKING HEEL	WORKING PRESSURE	CRANE WEIGHT WITHOUT STABILIZERS	OIL TANK CAPACITY	OIL FLOW	DIMENSIONS mm B x h x S
	tm	m	°	s/180°	°	bar	kg	l	l/min	
HC243 E2	22,5	11,7	415	12	4	315	2315	130	80	2520x2300x935
HC243 E3	-	13,8	415	12	4	310	2455	130	80	2520x2300x935
HC243 E4	-	15,9	415	12	4	310	2595	130	80	2520x2300x935
HC243 E5	-	18,1	415	12	4	310	2720	130	80	2520x2300x935
HC243 E6	-	20,3	415	12	4	310	2825	130	80	2520x2300x935
HC243 E7	-	22,5	415	12	4	310	2945	130	80	2520x2300x1005
HC243 E8	-	24,8	415	12	4	310	3035	130	80	2520x2300x1005
HC243 E4J3	-	24,1	415	12	4	325	3255	130	80	2520x2715x1055
HC243 E5J3	-	25,6	415	12	4	330	3210	130	80	2520x2615x1055
HC243 E6J2	-	25,9	415	12	4	325	3100	130	80	2520x2605x1055

HC 243K

EES
SDS
LAS



HC243K E2

	22720*	8000*	6090	4455	3190
kg	1,00	2,77	3,72	5,06	7,03
m					

HC243K E3

	21880*	8000*	5865	4255	3010	2305
kg	1,00	2,66	3,73	5,06	7,03	9,10
m						

HC243K E4

	21150*	8000*	5550	4005	2800	2115	1710
kg	1,00	2,57	3,81	5,14	7,11	9,18	11,25
m							

*) Theoretical lifting capacity •) Max lifting capacity
**) Fixed hook capacity

CE	<input checked="" type="checkbox"/>
NO CE	<input checked="" type="checkbox"/>
MANUAL	<input checked="" type="checkbox"/>
RADIO	<input checked="" type="checkbox"/>

HC 243K



EES Extra Extension Speed
SDS Smooth Descent System
LAS Liftrod Articulating System

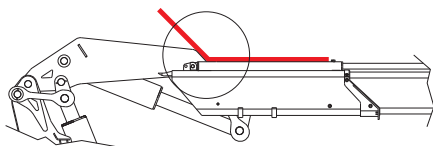

Second boom with negative angle in order to simplify operations in difficult access conditions

MODELS	LIFTING MOMENT	MAX VERTICAL REACH (HYDR)	SLEWING ANGLE	SLEWING TIME	MAX WORKING HEEL	WORKING PRESSURE	CRANE WEIGHT WITHOUT STABILIZERS	OIL TANK CAPACITY	OIL FLOW	DIMENSIONS
HC243K E2	22,7	10,7	415	12	4	300	2245	130	80	2520x2300x930
HC243K E3	-	12,8	415	12	4	300	2385	130	80	2520x2300x930
HC243K E4	-	14,9	415	12	4	300	2525	130	80	2520x2300x930

HC 261

EES
SDS
P-LCS
LAS



HC261 E2

kg	24800*	8000*	5795	3965	3015
m	1,00	3,02	4,28	6,18	8,08

CE	<input checked="" type="checkbox"/>
NO CE	<input checked="" type="checkbox"/>
MANUAL	<input type="checkbox"/>
RADIO	<input checked="" type="checkbox"/>

HC261 E3

kg	24310*	8000*	5680	3850	2895	2300	1845	1500	1000
m	1,00	2,96	4,28	6,18	8,08	10,11	12,22	14,44	16,65

HC261 E4

kg	23780*	8000*	5455	3670	2735	2145	1775	1430	1175	605
m	1,00	2,89	4,36	6,26	8,16	10,19	12,22	14,44	16,65	18,90

HC261 E5

kg	23350*	8000*	5260	3515	2595	2010	1640	1385	1145	960	535
m	1,00	2,83	4,44	6,34	8,24	10,27	12,30	14,43	16,65	18,90	21,18

HC261 E6

kg	22970*	8000*	5070	3365	2460	1880	1510	1260	1085	765	680
m	1,00	2,77	4,53	6,43	8,33	10,36	12,39	14,52	16,65	18,90	21,18

HC261 E7

kg	22340*	8000*	4910	3240	2345	1770	1405	1150	980	855	725	630
m	1,00	2,73	4,61	6,51	8,41	10,44	12,47	14,60	16,73	18,90	21,18	23,28

HC261 E8

kg	22350*	8000*	4755	3120	2240	1670	1310	1060	885	765	680	580
m	1,00	2,67	4,70	6,60	8,50	10,53	12,56	14,69	16,82	18,98	21,18	23,28

HC261 E4J3

kg							855	745	660	595	510	435
m							15,21	16,91	18,66	20,41	22,30	24,21

HC261 E5J3

kg								695	625	570	525	465	415
m								17,26	18,82	20,38	21,94	23,60	25,38

HC261 E6J2

kg									650	600	560	390
m									19,38	20,76	22,24	23,80

*) Theoretical lifting capacity *)Max lifting capacity

HC 261



EES Extra Extension Speed
SDS Smooth Descent System
P-LCS Proportional Lift Control System
LAS Liftrod Articulating System

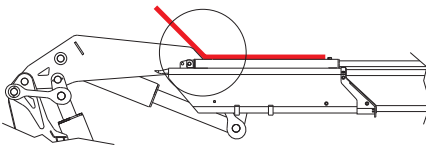

Second boom with negative angle in order to simplify operations in difficult access conditions

MODELS	LIFTING MOMENT	MAX VERTICAL REACH (HYDR)	SLEWING ANGLE	SLEWING TIME	MAX WORKING HEEL	WORKING PRESSURE	CRANE WEIGHT WITHOUT STABILIZERS	OIL TANK CAPACITY	OIL FLOW	DIMENSIONS mm B x h x S
	tm	m	°	s/180°	°	bar	kg	l	l/min	
HC261 E2	24,8	11,7	415	12	4	345	2315	130	80	2520x2300x935
HC261 E3	-	13,8	415	12	4	345	2455	130	80	2520x2300x935
HC261 E4	-	15,9	415	12	4	345	2595	130	80	2520x2300x935
HC261 E5	-	18,1	415	12	4	345	2720	130	80	2520x2300x935
HC261 E6	-	20,3	415	12	4	345	2825	130	80	2520x2300x935
HC261 E7	-	22,5	415	12	4	345	2945	130	80	2520x2300x1005
HC261 E8	-	24,8	415	12	4	345	3035	130	80	2520x2300x1005
HC261 E4J3	-	24,1	415	12	3	355	3255	130	80	2520x2715x1055
HC261 E5J3	-	25,6	415	12	3	350	3210	130	80	2520x2615x1055
HC261 E6J2	-	25,9	415	12	3	350	3100	130	80	2520x2605x1055

HC 265e

- EES**
- SDS**
- P-LCS**
- LAS**



- CE**
- NO CE**
- MANUAL**
- RADIO**

HC265e E2

kg	24800*	8000°	5795	3965	3015
m	1,00	3,02	4,28	6,18	8,08

HC265e E3

kg	24310*	8000°	5680	3850	2895	2300	1845	1430	1145
m	1,00	2,96	4,28	6,18	8,08	10,11	12,22	14,44	16,65

HC265e E4

kg	23780*	8000°	5455	3670	2735	2145	1775	1430	1145	910
m	1,00	2,89	4,36	6,26	8,16	10,19	12,22	14,44	16,65	18,90

HC265e E5

kg	23350*	8000°	5260	3515	2595	2010	1640	1385	1145	910	715
m	1,00	2,83	4,44	6,34	8,24	10,27	12,30	14,43	16,65	18,90	21,18

HC265e E6

kg	22970*	8000°	5070	3365	2460	1880	1510	1260	1085	910	715
m	1,00	2,77	4,53	6,43	8,33	10,36	12,39	14,52	16,65	18,90	21,18

HC265e E7

kg	22340*	8000°	4910	3240	2345	1770	1405	1150	980	855	715	580
m	1,00	2,73	4,61	6,51	8,41	10,44	12,47	14,60	16,73	18,90	21,18	23,28

HC265e E8

kg	22350*	8000°	4755	3120	2240	1670	1310	1060	885	765	670	580
m	1,00	2,67	4,70	6,60	8,50	10,53	12,56	14,69	16,82	18,98	21,18	23,28

HC265e E4J3

kg								855	745	660	595	510	435
m								15,21	16,91	18,66	20,41	22,30	24,21

HC265e E5J3

kg									695	625	570	525	465	415
m									17,26	18,82	20,38	21,94	23,60	25,38

HC265e E6J2

kg										650	600	560	390
m										19,38	20,76	22,24	23,80

*) Theoretical lifting capacity °) Max lifting capacity

HC 265e



- EES Extra Extension Speed**
- SDS Smooth Descent System**
- P-LCS Proportional Lift Control System**
- LAS Liftrod Articulating System**

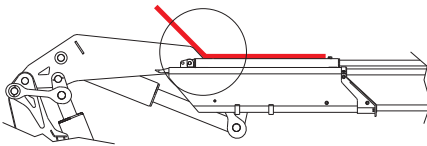

Second boom with negative angle in order to simplify operations in difficult access conditions

MODELS	LIFTING MOMENT	MAX VERTICAL REACH (HYDR)	SLEWING ANGLE	SLEWING TIME	MAX WORKING HEEL	WORKING PRESSURE	CRANE WEIGHT WITHOUT STABILIZERS	OIL TANK CAPACITY	OIL FLOW	DIMENSIONS mm B x h x S
	tm	m	°	s/180°	°	bar	kg	l	l/min	
HC265e E2	24,8	11,7	Endless	30	4	345	2460	130	80	2530x2335x980
HC265e E3	-	13,8	Endless	30	4	345	2600	130	80	2530x2335x980
HC265e E4	-	15,9	Endless	30	4	345	2740	130	80	2530x2335x980
HC265e E5	-	18,1	Endless	30	4	345	2865	130	80	2530x2335x980
HC265e E6	-	20,3	Endless	30	4	345	2970	130	80	2530x2335x980
HC265e E7	-	22,5	Endless	30	4	345	3090	130	80	2530x2335x1055
HC265e E8	-	24,8	Endless	30	4	345	3180	130	80	2530x2335x1055
HC265e E4J3	-	24,4	Endless	30	3	355	3400	130	80	2550x2700x1100
HC265e E5J3	-	25,6	Endless	30	3	350	3355	130	80	2550x2595x1100
HC265e E6J2	-	25,9	Endless	30	3	350	3245	130	80	2540x2580x1100

HC 291

EES

SDS

LCS

LAS



HC291 E2

kg	27310*	11390**	6000	4165	3190	2415	1890	1470
m	1,00	2,40	4,51	6,38	8,25	10,23	12,20	14,38

HC291 E3

kg	27090*	11270**	5940	4035	3040	2415	1890	1470	1155
m	1,00	2,40	4,56	6,43	8,30	10,25	12,20	14,38	16,57

HC291 E4

kg	26150*	10880**	5735	3885	2900	2285	1890	1470	1155	895
m	1,00	2,40	4,56	6,43	8,30	10,25	12,20	14,38	16,57	18,86

HC291 E5

kg	25610*	10670**	5515	3710	2740	2125	1750	1470	1155	895	705
m	1,00	2,40	4,64	6,51	8,38	10,33	12,28	14,38	16,57	18,86	21,14

HC291 E6

kg	25260*	10510**	5340	3570	2610	2010	1620	1345	1155	895	705	565
m	1,00	2,40	4,73	6,60	8,47	10,42	12,37	14,47	16,57	18,86	21,14	23,33

HC291 E7

kg	24800*	10310**	5145	3410	2465	1880	1500	1225	1035	895	705	565
m	1,00	2,40	4,82	6,69	8,56	10,51	12,46	14,56	16,66	18,86	21,14	23,33

HC291 E8

kg	24340*	10140**	4965	3275	2345	1770	1390	1125	935	805	705	565
m	1,00	2,40	4,90	6,77	8,64	10,59	12,54	14,64	16,74	18,94	21,14	23,33

HC291 E6J4

kg									475	420	375	345	315	245
m									19,65	21,25	22,80	24,19	25,79	27,60

CE	<input checked="" type="checkbox"/>
NO CE	<input checked="" type="checkbox"/>
MANUAL	<input checked="" type="checkbox"/>
RADIO	<input checked="" type="checkbox"/>

*) Theoretical lifting capacity

**) Fixed hook capacity

HC 291



- EES** Extra Extension Speed
- SDS** Smooth Descent System
- LCS** Lift Control System
- LAS** Liftrod Articulating System

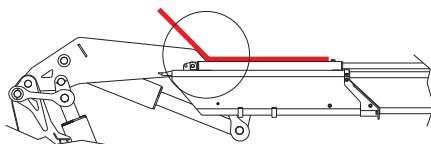

Second boom with negative angle in order to simplify operations in difficult access conditions

MODELS	LIFTING MOMENT	MAX VERTICAL REACH (HYDR)	SLEWING ANGLE	SLEWING TIME	MAX WORKING HEEL	WORKING PRESSURE	CRANE WEIGHT WITHOUT STABILIZERS	OIL TANK CAPACITY	OIL FLOW	DIMENSIONS mm B x h x S
	tm	m	°	s/180°	°	bar	kg	l	l/min	
HC291 E2	27,3	11,9	425	22	4	325	2635	180	80	2510x2350x1010
HC291 E3	-	13,8	425	22	4	325	2795	180	80	2510x2350x1010
HC291 E4	-	15,8	425	22	4	325	2950	180	80	2510x2350x1010
HC291 E5	-	17,9	425	22	4	325	3090	180	80	2510x2350x1040
HC291 E6	-	20,1	425	22	4	325	3215	180	80	2510x2350x1060
HC291 E7	-	22,4	425	22	4	325	3330	180	80	2510x2350x1160
HC291 E8	-	24,7	425	22	4	325	3430	180	80	2510x2350x1180
HC291 E6J4	-	29,1	425	22	4	325	3790	180	80	2510x2705x1190

HC 331

EES
SDS
LAS



HC331 E1

kg	31220*	11930**	7770	5430	3900	2815	2115
m	1,00	2,52	3,98	5,75	7,55	9,60	11,69

HC331 E2

kg	30290*	11625**	7610	5170	3900	2815	2115	1600
m	1,00	2,52	3,98	5,75	7,60	9,60	11,69	13,98

HC331 E3

kg	29600*	11320**	7400	5015	3715	2895	2115	1600	1220
m	1,00	2,52	4,00	5,75	7,60	9,60	11,70	14,00	16,30

HC331 E4

kg	29010*	11010**	7075	4765	3495	2680	2195	1600	1220	960
m	1,00	2,52	4,10	5,85	7,70	9,70	11,70	14,00	16,30	18,65

HC331 E5

kg	28500*	10705**	6785	4555	3320	2510	2020	1680	1220	960	785
m	1,00	2,52	4,20	5,95	7,80	9,80	11,80	14,00	16,30	18,65	20,75

HC331 E6

kg	27800*	10450**	6540	4335	3125	2345	1860	1520	1295	960	785
m	1,00	2,52	4,25	6,10	7,90	9,90	11,90	14,10	16,30	18,65	20,75

HC331 E7

kg	27210*	10195**	6185	4125	2970	2200	1715	1375	1150	1005	785
m	1,00	2,52	4,40	6,20	8,10	10,10	12,10	14,30	16,50	18,65	20,75

HC331 E8

kg	26780*	10145**	5950	3920	2785	2035	1585	1255	1035	885	785	400
m	1,00	2,52	4,50	6,30	8,20	10,20	12,20	14,40	16,60	18,80	20,95	23,40

HC331 E4J4

kg									1090	940	815	695	605	420
m									14,60	16,30	18,10	19,80	21,60	23,40

HC331 E5J4

kg										705	605	525	460	420	330
m										16,80	18,50	20,20	22,00	23,80	25,70

CE	<input checked="" type="checkbox"/>
NO CE	<input checked="" type="checkbox"/>
MANUAL	<input checked="" type="checkbox"/>
RADIO	<input checked="" type="checkbox"/>

*) Theoretical lifting capacity
**) Fixed hook capacity

HC 331



EES Extra Extension Speed
SDS Smooth Descent System
LAS Liftrod Articulating System

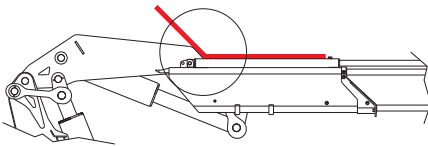

Second boom with negative angle in order to simplify operations in difficult access conditions

MODELS	LIFTING MOMENT	MAX VERTICAL REACH (HYDR)	SLEWING ANGLE	SLEWING TIME	MAX WORKING HEEL	WORKING PRESSURE	CRANE WEIGHT WITHOUT STABILIZERS	OIL TANK CAPACITY	OIL FLOW	DIMENSIONS
	tm	m	°	s/180°	°	bar	kg	l	l/min	
HC331 E1	31,2	9,9	397	25	4	300	3050	160	45	2540x2355x1170
HC331 E2	-	11,8	397	25	4	300	3280	160	45	2540x2355x1170
HC331 E3	-	13,8	397	25	4	300	3500	160	45	2540x2355x1170
HC331 E4	-	15,8	397	25	4	300	3730	160	45	2540x2355x1170
HC331 E5	-	18,1	397	25	4	300	3900	160	45	2540x2355x1170
HC331 E6	-	20,4	397	25	4	300	4060	160	45	2540x2405x1170
HC331 E7	-	22,7	397	25	4	300	4180	160	45	2540x2490x1300
HC331 E8	-	25,0	397	25	4	300	4300	160	45	2540x2550x1300
HC331 E4J4	-	25,7	397	30	4	290	4570	160	45	2540x2620x1330
HC331 E5J4	-	28,0	397	30	4	290	4740	160	45	2545x2620x1330

HC 361



- EES** Extra Extension Speed
- SDS** Smooth Descent System
- LCS** Lift Control System
- LAS** Liftrød Articulating System

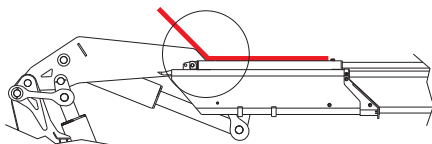

Second boom with negative angle in order to simplify operations in difficult access conditions

MODELS	LIFTING MOMENT	MAX VERTICAL REACH (HYDR)	SLEWING ANGLE	SLEWING TIME	MAX WORKING HEEL	WORKING PRESSURE	CRANE WEIGHT WITHOUT STABILIZERS	OIL TANK CAPACITY	OIL FLOW	DIMENSIONS
	tm	m	°	s/180°	°	bar	kg	l	l/min	
HC361 E1	32,4	9,9	397	25	4	310	3050	160	45	2540x2355x1170
HC361 E2	-	11,8	397	25	4	310	3280	160	45	2540x2355x1170
HC361 E3	-	13,8	397	25	4	310	3500	160	45	2540x2355x1170
HC361 E4	-	15,8	397	25	4	310	3730	160	45	2540x2355x1170
HC361 E5	-	18,1	397	25	4	310	3900	160	45	2540x2355x1170
HC361 E6	-	20,4	397	25	4	310	4060	160	45	2540x2405x1170
HC361 E7	-	22,7	397	25	4	310	4180	160	45	2540x2490x1300
HC361 E8	-	25,0	397	25	4	310	4300	160	45	2540x2550x1300
HC361 E4J4	-	25,7	397	30	4	310	4570	160	45	2540x2620x1330
HC361 E5J4	-	28,0	397	30	4	310	4740	160	45	2545x2620x1330

HC 401

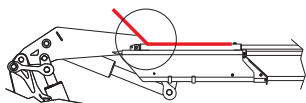
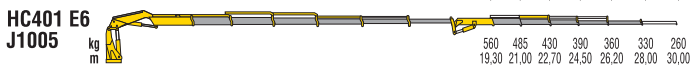
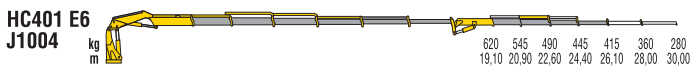

Second boom with negative angle in order to simplify operations in difficult access conditions

MODELS	LIFTING MOMENT	MAX VERTICAL REACH (HYDR)	SLEWING ANGLE	SLEWING TIME	MAX WORKING HEEL	WORKING PRESSURE	CRANE WEIGHT WITHOUT STABILIZERS	OIL TANK CAPACITY	OIL FLOW	DIMENSIONS mm B x h x S
	tm	m	°	s/180°	°	bar	kg	l	l/min	
HC401 E2	34,8	12,0	430	30	4	325	3250	230	100	2500x2440x1220
HC401 E3	-	14,0	430	30	4	325	3480	230	100	2500x2440x1250
HC401 E4	-	16,0	430	30	4	325	3700	230	100	2500x2440x1250
HC401 E5	-	18,0	430	30	4	325	3910	230	100	2500x2440x1250
HC401 E6	-	20,3	430	30	4	325	4100	230	100	2500x2440x1250
HC401 E7	-	22,6	430	30	4	325	4280	230	100	2500x2440x1350
HC401 E8	-	24,8	430	30	4	325	4450	230	100	2500x2440x1350
HC401 E4 J1003	-	24,3	430	30	3	-	4320	230	100	2500x2740x1330
HC401 E4 J1004	-	26,1	430	30	3	-	4390	230	100	2500x2740x1330
HC401 E5 J1003	-	26,4	430	30	3	-	4530	230	100	2500x2720x1330
HC401 E5 J1004	-	28,2	430	30	3	345	4600	230	100	2500x2720x1330
HC401 E6 J1003	-	28,5	430	30	3	-	4720	230	100	2510x2740x1330
HC401 E6 J1004	-	30,4	430	30	3	-	4790	230	100	2510x2740x1330
HC401 E6 J1005	-	32,3	430	30	3	-	4850	230	100	2510x2740x1330

HC 401K

EES
SDS
LAS



HC401K E2

kg	33000	11500*	8830	7010	5000	3665	2800	2155	1700
m	1,00	2,78	3,73	4,70	6,60	8,68	10,73	12,90	15,00

HC401K E3

kg	32540	11500*	8540	6760	4780	3665	2800	2155	1700	1320
m	1,00	2,73	3,81	4,78	6,68	8,68	10,73	12,90	15,00	17,35

HC401K E4

kg	32040	11500*	8300	6520	4570	3460	2800	2155	1700	1320	1025
m	1,00	2,68	3,86	4,83	6,73	8,73	10,73	12,90	15,00	17,35	19,50

HC401K E5

kg	31440	11500*	7980	6270	4350	3250	2600	2155	1700	1320	1025	800
m	1,00	2,62	3,94	4,90	6,80	8,80	10,80	12,90	15,00	17,35	19,50	21,60

HC401K E6

kg	30950	11500*	7855	6130	4200	3100	2430	1990	1700	1320	1025	800	450
m	1,00	2,57	3,94	4,90	6,80	8,80	10,80	12,90	15,00	17,35	19,50	21,60	23,70

HC401K E7

kg	30520	11500*	7445	5820	3970	2900	2250	1810	1520	1320	1025	800	450
m	1,00	2,54	4,10	5,10	7,00	9,00	11,00	13,10	15,20	17,35	19,50	21,60	23,70

HC401K E8

kg	29850	11500*	7280	5660	3820	2740	2100	1660	1370	1170	1025	800	450
m	1,00	2,48	4,10	5,10	7,00	9,00	11,00	13,10	15,20	17,35	19,50	21,60	23,70

CE	<input checked="" type="checkbox"/>
NO CE	<input checked="" type="checkbox"/>
MANUAL	<input checked="" type="checkbox"/>
RADIO	<input checked="" type="checkbox"/>

*) Theoretical lifting capacity •) Max lifting capacity

HC 401K



EES Extra Extension Speed
SDS Smooth Descent System
LAS Liftrod Articulating System

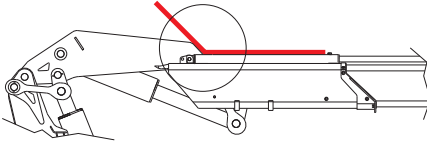

Second boom with negative angle in order to simplify operations in difficult access conditions

MODELS	LIFTING MOMENT	MAX VERTICAL REACH (HYDR)	SLEWING ANGLE	SLEWING TIME	MAX WORKING HEEL	WORKING PRESSURE	CRANE WEIGHT WITHOUT STABILIZERS	OIL TANK CAPACITY	OIL FLOW	DIMENSIONS
	tm	m	°	s/180°	°	bar	kg	l	l/min	
HC401K E2	32,9	10,6	430	30	4	325	3150	230	100	2500x2440x1195
HC401K E3	-	12,7	430	30	4	325	3380	230	100	2500x2440x1195
HC401K E4	-	14,8	430	30	4	325	3600	230	100	2500x2440x1240
HC401K E5	-	16,9	430	30	4	325	3810	230	100	2500x2440x1240
HC401K E6	-	19,0	430	30	4	325	4000	230	100	2500x2440x1240
HC401K E7	-	21,3	430	30	4	325	4180	230	100	2500x2440x1350
HC401K E8	-	23,5	430	30	4	325	4350	230	100	2500x2440x1350

HC 405e

**HC405e
J1004**

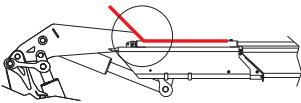
**HC405e
J1005**









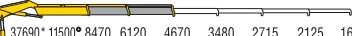
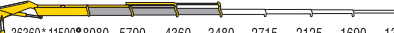

Second boom with negative angle in order to simplify operations in difficult access conditions

MODELS	LIFTING MOMENT	MAX VERTICAL REACH (HYDR)	GEAR MOTOR (STD)	SLEWING ANGLE	SLEWING TIME	MAX WORKING HEEL	WORKING PRESSURE	CRANE WEIGHT WITHOUT STABILIZERS	OIL TANK CAPACITY	OIL FLOW	DIMENSIONS
	tm	m	N.	°	s/180°	°	bar	kg	l	l/min	
HC405e E2	34,8	12,0	1	ENDLESS	-	4	325	3500	230	100	2500x2465x1210
HC405e E3	-	14,0	1		-	4	325	3730	230	100	2500x2465x1240
HC405e E4	-	16,0	1		-	4	325	3950	230	100	2500x2465x1240
HC405e E5	-	18,0	1		-	4	325	4160	230	100	2500x2465x1240
HC405e E6	-	20,3	1		-	4	325	4350	230	100	2510x2465x1240
HC405e E7	-	22,6	1		-	4	325	4530	230	100	2510x2465x1345
HC405e E8	-	24,8	1		-	4	325	4700	230	100	2510x2465x1345
HC405e E4 J1003	-	24,3	2		30	3	-	4620	230	100	2510x2760x1330
HC405e E4 J1004	-	26,1	2		30	3	-	4690	230	100	2510x2760x1330
HC405e E5 J1003	-	26,4	2		30	3	-	4830	230	100	2510x2760x1330
HC405e E5 J1004	-	28,2	2		30	3	345	4900	230	100	2510x2760x1330
HC405e E6 J1003	-	28,5	2		30	3	-	5020	230	100	2510x2760x1330
HC405e E6 J1004	-	30,4	2		30	3	-	5090	230	100	2510x2760x1330
HC405e E6 J1005	-	32,3	2		30	3	-	5150	230	100	2510x2760x1330

HC 441

- EES**
- SDS**
- P-LCS**
- LAS**



HC441 E2			CE <input checked="" type="checkbox"/>											
kg	37690*	11500*	8470	6120	4670	3480	2715	2125	1690		NO CE <input checked="" type="checkbox"/>			
m	1,00	3,17	4,45	6,12	8,02	10,10	12,15	14,30	16,40		MANUAL <input checked="" type="checkbox"/>			
HC441 E3			RADIO <input checked="" type="checkbox"/>											
kg	36360*	11500*	8080	5790	4360	3480	2715	2125	1690	1330				
m	1,00	3,06	4,50	6,20	8,10	10,10	12,15	14,30	16,40	18,72				
HC441 E4														
kg	35580*	11500*	7820	5560	4150	3270	2715	2125	1690	1330	1055			
m	1,00	2,98	4,55	6,22	8,15	10,15	12,15	14,30	16,40	18,72	20,90			
HC441 E5														
kg	34910*	11500*	7540	5330	3940	3065	2510	2125	1690	1330	1055	880		
m	1,00	2,92	4,63	6,30	8,20	10,20	12,20	14,30	16,40	18,72	20,90	23,00		
HC441 E6														
kg	34220*	11500*	7390	5180	3775	2900	2340	1960	1690	1330	1055	880	550	
m	1,00	2,86	4,63	6,30	8,20	10,20	12,20	14,30	16,40	18,72	20,90	23,00	25,10	
HC441 E7														
kg	33740*	11500*	7030	4915	3560	2710	2165	1780	1520	1330	1055	880	550	
m	1,00	2,80	4,80	6,50	8,40	10,40	12,40	14,50	16,60	18,72	20,90	23,00	25,10	
HC441 E8														
kg	33120*	11500*	6900	4750	3420	2570	2020	1640	1375	1190	1055	880	550	
m	1,00	2,72	4,80	6,50	8,40	10,40	12,40	14,50	16,60	18,75	20,90	23,00	25,10	
HC441 E4 J1003														
kg								1460	1290	1160	1050	780	570	350
m								14,80	16,50	18,20	20,00	21,70	23,70	25,60
HC441 E4 J1004														
kg								1390	1220	1085	975	780	570	350
m								15,00	16,70	18,40	20,20	21,90	23,80	25,70
HC441 E5 J1003														
kg								1050	930	840	770	680	570	350
m								17,00	18,70	20,40	22,20	23,90	25,80	27,70
HC441 E5 J1004														
kg								985	870	780	710	655	520	350
m								17,10	18,80	20,50	22,30	24,00	25,90	27,90
HC441 E6 J1003														
kg								790	705	640	580	510	390	320
m								19,10	20,80	22,50	24,30	26,10	28,00	30,00

*) Theoretical lifting capacity *)Max lifting capacity

HC 441 X

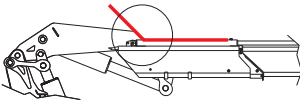
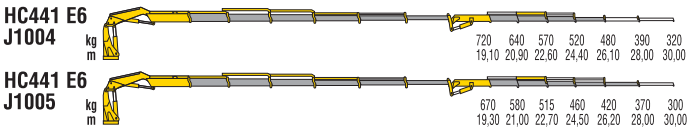











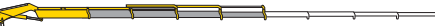

Second boom with negative angle in order to simplify operations in difficult access conditions

MODELS	LIFTING MOMENT	MAX VERTICAL REACH (HYDR)	SLEWING ANGLE	SLEWING TIME	MAX WORKING HEEL	WORKING PRESSURE	CRANE WEIGHT WITHOUT STABILIZERS	OIL TANK CAPACITY	OIL FLOW	DIMENSIONS
	tm	m	°	s/180°	°	bar	kg	l	l/min	
HC441 E2	37,7	12,0	430	30	4	345	3250	230	100	2500x2440x1220
HC441 E3	-	14,0	430	30	4	345	3480	230	100	2500x2440x1250
HC441 E4	-	16,0	430	30	4	345	3700	230	100	2500x2440x1250
HC441 E5	-	18,0	430	30	4	345	3910	230	100	2500x2440x1250
HC441 E6	-	20,3	430	30	4	345	4100	230	100	2500x2440x1250
HC441 E7	-	22,6	430	30	4	345	4280	230	100	2500x2440x1350
HC441 E8	-	24,8	430	30	4	345	4450	230	100	2500x2440x1350
HC441 E4 J1003	-	24,3	430	30	3	-	4320	230	100	2500x2740x1330
HC441 E4 J1004	-	26,1	430	30	3	-	4390	230	100	2500x2740x1330
HC441 E5 J1003	-	26,4	430	30	3	-	4530	230	100	2500x2720x1330
HC441 E5 J1004	-	28,2	430	30	3	345	4600	230	100	2500x2720x1330
HC441 E6 J1003	-	28,5	430	30	3	-	4720	230	100	2510x2740x1330
HC441 E6 J1004	-	30,4	430	30	3	-	4790	230	100	2510x2740x1330
HC441 E6 J1005	-	32,3	430	30	3	-	4850	230	100	2510x2740x1330

HC 445e

- EES**
- SDS**
- P-LCS**
- LAS**



HC445e E2	 kg 37690* 11500* 8470 6120 4670 3480 2715 2125 1690 m 1,00 3,17 4,45 6,12 8,02 10,10 12,15 14,30 16,40	<table border="1" style="width: 100%; border-collapse: collapse;"> <tr><td>CE</td><td style="text-align: center;"><input checked="" type="checkbox"/></td></tr> <tr><td>NO CE</td><td style="text-align: center;"><input checked="" type="checkbox"/></td></tr> <tr><td>MANUAL</td><td style="text-align: center;"><input checked="" type="checkbox"/></td></tr> <tr><td>RADIO</td><td style="text-align: center;"><input checked="" type="checkbox"/></td></tr> </table>	CE	<input checked="" type="checkbox"/>	NO CE	<input checked="" type="checkbox"/>	MANUAL	<input checked="" type="checkbox"/>	RADIO	<input checked="" type="checkbox"/>
CE	<input checked="" type="checkbox"/>									
NO CE	<input checked="" type="checkbox"/>									
MANUAL	<input checked="" type="checkbox"/>									
RADIO	<input checked="" type="checkbox"/>									
HC445e E3	 kg 36360* 11500* 8080 5790 4360 3480 2715 2125 1690 1330 m 1,00 3,06 4,50 6,20 8,10 10,10 12,15 14,30 16,40 18,72									
HC445e E4	 kg 35580* 11500* 7820 5560 4150 3270 2715 2125 1690 1330 1055 m 1,00 2,98 4,55 6,22 8,15 10,15 12,15 14,30 16,40 18,72 20,90									
HC445e E5	 kg 34910* 11500* 7540 5330 3940 3065 2510 2125 1690 1330 1055 880 m 1,00 2,92 4,63 6,30 8,20 10,20 12,20 14,30 16,40 18,72 20,90 23,00									
HC445e E6	 kg 34220* 11500* 7390 5180 3775 2900 2340 1960 1690 1330 1055 880 550 m 1,00 2,86 4,63 6,30 8,20 10,20 12,20 14,30 16,40 18,72 20,90 23,00 25,10									
HC445e E7	 kg 33740* 11500* 7030 4915 3560 2710 2165 1780 1520 1330 1055 880 550 m 1,00 2,80 4,80 6,50 8,40 10,40 12,40 14,50 16,60 18,72 20,90 23,00 25,10									
HC445e E8	 kg 33120* 11500* 6900 4750 3420 2570 2020 1640 1375 1190 1055 880 550 m 1,00 2,72 4,80 6,50 8,40 10,40 12,40 14,50 16,60 18,75 20,90 23,00 25,10									
HC445e E4 J1003	 kg 1460 1290 1160 1050 780 570 350 m 14,80 16,50 18,20 20,00 21,70 23,70 25,60									
HC445e E4 J1004	 kg 1390 1220 1085 975 780 570 350 m 15,00 16,70 18,40 20,20 21,90 23,80 25,70									
HC445e E5 J1003	 kg 1050 930 840 770 680 570 350 m 17,00 18,70 20,40 22,20 23,90 25,80 27,70									
HC445e E5 J1004	 kg 985 870 780 710 655 520 350 m 17,10 18,80 20,50 22,30 24,00 25,90 27,90									
HC445e E6 J1003	 kg 790 705 640 590 510 390 320 m 19,10 20,80 22,50 24,30 26,10 28,00 30,00									

*) Theoretical lifting capacity *)Max lifting capacity

HC 445e

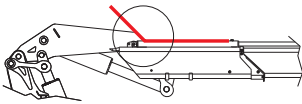

Second boom with negative angle in order to simplify operations in difficult access conditions

MODELS	LIFTING MOMENT	MAX VERTICAL REACH (HYDR)	GEAR MOTOR (STD)	SLEWING ANGLE	SLEWING TIME	MAX WORKING HEEL	WORKING PRESSURE	CRANE WEIGHT WITHOUT STABILIZERS	OIL TANK CAPACITY	OIL FLOW	DIMENSIONS
	tm	m	N.	°	s/180°	°	bar	kg	l	l/min	
HC445e E2	37,7	12,0	1	ENDLESS	-	4	325	3500	230	100	2500x2465x1210
HC445e E3	-	14,0	1		-	4	325	3730	230	100	2500x2465x1240
HC445e E4	-	16,0	1		-	4	325	3950	230	100	2500x2465x1240
HC445e E5	-	18,0	1		-	4	325	4160	230	100	2500x2465x1240
HC445e E6	-	20,3	1		-	4	325	4350	230	100	2510x2465x1240
HC445e E7	-	22,6	1		-	4	325	4530	230	100	2510x2465x1345
HC445e E8	-	24,8	1		-	4	325	4700	230	100	2510x2465x1345
HC445e E4 J1003	-	24,3	2		30	3	-	4620	230	100	2510x2760x1330
HC445e E4 J1004	-	26,1	2		30	3	-	4690	230	100	2510x2760x1330
HC445e E5 J1003	-	26,4	2		30	3	-	4830	230	100	2510x2760x1330
HC445e E5 J1004	-	28,2	2		30	3	345	4900	230	100	2510x2760x1330
HC445e E6 J1003	-	28,5	2		30	3	-	5020	230	100	2510x2760x1330
HC445e E6 J1004	-	30,4	2		30	3	-	5090	230	100	2510x2760x1330
HC445e E6 J1005	-	32,3	2		30	3	-	5150	230	100	2510x2760x1330

HC 501



- EES** Extra Extension Speed
- SDS** Smooth Descent System
- TCU** Total Control Unit
- LCS** Lift Control System
- LAS** Liftrod Articulating System

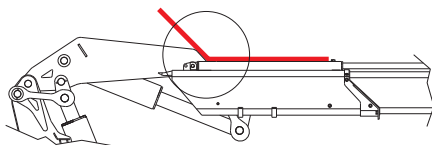

Second boom with negative angle in order to simplify operations in difficult access conditions

MODELS	LIFTING MOMENT	MAX VERTICAL REACH (HYDR)	SLEWING ANGLE	SLEWING TIME	MAX WORKING HEEL	WORKING PRESSURE	CRANE WEIGHT WITHOUT STABILIZERS	OIL TANK CAPACITY	OIL FLOW	DIMENSIONS mm B x h x S
	tm	m	°	s/180°	°	bar	kg	l	l/min	
HC501 E2	45,0	12,1	400	25	4	315	4040	210	80	2505x2460x1275
HC501 E3	-	14,1	400	25	4	315	4290	210	80	2505x2460x1275
HC501 E4	-	16,1	400	25	4	315	4570	210	80	2505x2460x1275
HC501 E5	-	18,2	400	25	4	315	4810	210	80	2505x2460x1285
HC501 E6	-	20,3	400	25	4	315	5010	210	80	2505x2460x1285
HC501 E7	-	22,5	400	25	4	315	5200	210	80	2505x2460x1400
HC501 E8	-	24,7	400	25	4	315	5380	210	80	2510x2480x1400
HC501 E6J4	-	30,1	400	25	4	315	5880	210	80	2515x2725x1470

HC 601e

EES
SDS
LAS



HC601e E2

kg	57480*	16000*	13000	9240	7185
m	1,00	3,42	4,35	6,15	8,00

HC601e E4

kg	54680*	16000*	12260	8625	6610	5270	4400	3195	2760	2045	1820
m	1,00	3,30	4,46	6,26	8,06	10,00	11,96	14,08	16,18	18,52	20,70

HC601e E6

kg	51920*	16000*	11590	8000	6005	4685	3820	3195	2760	2045	1820	1500	1150
m	1,00	3,11	4,48	6,28	8,10	10,05	11,98	14,08	16,18	18,52	20,70	22,85	25,00

HC601e E8

kg	50720*	16000*	10860	7450	5530	4240	3395	2780	2350	2045	1820	1500	1150
m	1,00	3,01	4,67	6,47	8,30	10,25	12,20	14,30	16,40	18,52	20,70	22,85	25,00

HC601e E6 J2002

kg									1300	1180	1080	820	760
m									19,50	21,10	22,70	24,40	26,10

HC601e E6 J2004

kg										1120	1010	900	820	760	570	530
m										19,60	21,20	22,80	24,40	26,10	28,00	29,80

HC601e E6 J2006

kg											960	850	755	675	620	570	530	420
m											19,65	21,30	22,90	24,50	26,20	28,00	29,80	31,00

HC601e E6 J1206

kg												1200	1060	950	865	795	735	685	500
m												19,65	21,30	22,90	24,50	26,20	28,00	29,80	31,00

CE	<input checked="" type="checkbox"/>
NO CE	<input checked="" type="checkbox"/>
MANUAL	<input checked="" type="checkbox"/>
RADIO	<input checked="" type="checkbox"/>

*) Theoretical lifting capacity *) Max lifting capacity

HC 601e



EES Extra Extension Speed
SDS Smooth Descent System
LAS Liftrod Articulating System

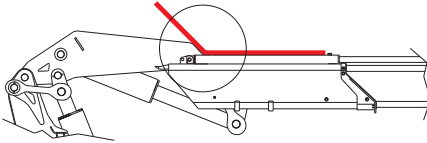

Second boom with negative angle in order to simplify operations in difficult access conditions

MODELS	LIFTING MOMENT		GEAR MOTOR (STD)	SLEWING ANGLE	SLEWING TIME (WITH 2 GEARMOTOR)	MAX WORKING HEEL	WORKING PRESSURE	CRANE WEIGHT WITHOUT STABILIZERS	OIL TANK CAPACITY	OIL FLOW	DIMENSIONS
	tm	m									
HC601e E2	57,5	11,9	1	ENDLESS	40	4	335	4625	250	100	2530x2430x1480
HC601e E4	-	15,9	1		40	4	335	5190	250	100	2530x2430x1480
HC601e E6	-	20,3	1		50	4	335	5715	250	100	2530x2430x1480
HC601e E8	-	24,7	2		50	4	335	6125	300	100	2550x2430x1635
HC601e E6 J2002	-	26,6	2		60	3	-	6820	250/300	100	2550x2740x1665
HC601e E6 J2004	-	30,1	2		60	3	-	7035	250/300	100	2550x2740x1665
HC601e E6 J2006	-	33,8	2		60	3	-	7205	250/300	100	2550x2740x1665
HC601e E6 J1206	-	33,8	2		60	3	-	6905	250/300	100	2550x2780x1665

HC 661e



EES Extra Extension Speed
SDS Smooth Descent System
P-LCS Proportional Lift Control System
LAS Liftrod Articulating System

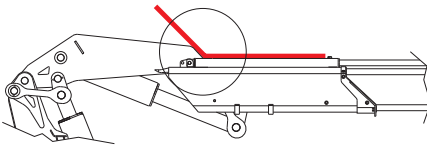

Second boom with negative angle in order to simplify operations in difficult access conditions

MODELS	LIFTING MOMENT	MAX VERTICAL REACH (HYDR)	GEAR MOTOR (STD)	SLEWING ANGLE	SLEWING TIME (WITH 2 GEARMOTOR)	MAX WORKING HEEL	WORKING PRESSURE	CRANE WEIGHT WITHOUT STABILIZERS	OIL TANK CAPACITY	OIL FLOW	DIMENSIONS mm B x h x S
	tm	m	N.	°	s/180°	°	bar	kg	l	l/min	
HC601e E2	63,2	11,9	1	ENDLESS	40	4	365	4625	250	100	2530x2430x1480
HC601e E4	-	15,9	1		40	4	365	5190	250	100	2530x2430x1480
HC601e E6	-	20,3	1		50	4	365	5715	250	100	2530x2430x1480
HC601e E8	-	24,7	2		50	4	365	6125	300	100	2550x2430x1635
HC601e E6 J2002	-	26,6	2		60	3	-	6820	250/300	100	2550x2740x1665
HC601e E6 J2004	-	30,1	2		60	3	-	7035	250/300	100	2550x2740x1665
HC601e E6 J2006	-	33,8	2		60	3	-	7205	250/300	100	2550x2740x1665
HC601e E6 J1206	-	33,8	2		60	3	-	6905	250/300	100	2550x2780x1665

HC 801

- EES**
- SDS**
- TCU**
- LCS**
- LAS**



HC801 E2

kg	73980*	24660*	17940	12830	9800
m	1,00	3,00	4,05	5,75	7,55

HC801 E4

kg	70290*	23430*	17035	12015	9050	7155	5920
m	1,00	3,00	4,12	5,85	7,65	9,55	11,45

HC801 E6

kg	67710*	22570*	15855	11160	8355	6480	5285	4440	3845	2920	2605	1950
m	1,00	3,00	4,27	6,00	7,77	9,70	11,60	13,60	15,60	17,60	19,60	22,00

HC801 E8

kg	65940*	21980*	15440	10695	7845	6020	4850	3975	3360	2920	2605	1950	1760	1360
m	1,00	3,00	4,27	6,00	7,77	9,70	11,60	13,60	15,60	17,60	19,60	22,00	24,15	26,50

HC801 E10

kg	65280*	21760*	14350	9955	7275	5505	4370	3550	2955	2515	2205	1950	1760	1310
m	1,00	3,00	4,55	6,25	8,05	10,00	11,85	13,85	15,85	17,85	19,85	22,00	24,15	26,50

HC801 E6J6

kg										1715	1510	1370	1245	1135	1045	925	630
m										18,80	20,40	22,05	23,70	25,40	27,20	29,00	31,00

HC801 E8J4

kg													960	860	780	715	665	555
m													22,20	23,90	25,65	27,40	29,20	31,10

*) Theoretical lifting capacity

CE	<input checked="" type="checkbox"/>
NO CE	<input checked="" type="checkbox"/>
MANUAL	<input type="checkbox"/>
RADIO	<input checked="" type="checkbox"/>

HC 801



- EES** Extra Extension Speed
- SDS** Smooth Descent System
- TCU** Total Control Unit
- LCS** Lift Control System
- LAS** Liftrod Articulating System

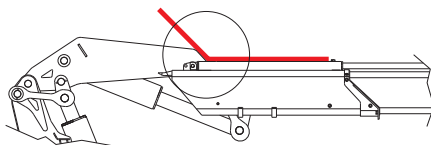

Second boom with negative angle in order to simplify operations in difficult access conditions

MODELS	LIFTING MOMENT	MAX VERTICAL REACH (HYDR)	GEAR MOTOR (STD)	SLEWING ANGLE	SLEWING TIME	MAX WORKING HEEL	WORKING PRESSURE	CRANE WEIGHT WITHOUT STABILIZERS	OIL TANK CAPACITY	OIL FLOW	DIMENSIONS
	tm	m	N.		s/180°	°	bar	kg	l	l/min	
HC801 E2	74,0	12,1	2	ENDLESS	40	4	315	6350	280	100	2530x2450x1610
HC801 E4	-	16,0	2		40	4	315	7000	280	100	2530x2450x1610
HC801 E6	-	20,2	2		50	4	315	7600	280	100	2530x2450x1770
HC801 E8	-	24,1	2		50	4	315	8150	280	100	2530x2505x1795
HC801 E10	-	28,7	2		60	4	315	8550	280	100	2530x2635x1795
HC801 E6J6	-	33,6	2		60	4	315	9100	280	100	2530x2800x1900
HC801 E8J4	-	34,0	2		60	4	315	9000	280	100	2545x2875x1900



HV

HV 27

HV 47

HV 77

HV 107

HV 147

HV 197

HV 227

When looking for a compact articulated crane, simple to operate, with high lifting capacity, HV line is the perfect solution for cost and performance

HV 27



HV27 E2

	2600*	1300*	835	575	440	325
kg	1,00	2,0	3,11	4,31	5,50	6,80
m						

HV27 E3

	2520*	1260*	785	535	405	325
kg	1,00	2,0	3,20	4,40	5,60	6,80
m						

CE	<input checked="" type="checkbox"/>
NO CE	<input checked="" type="checkbox"/>
MANUAL	<input checked="" type="checkbox"/>
RADIO	<input type="checkbox"/>

*) Theoretical lifting capacity

MODELS	LIFTING MOMENT	MAX VERTICAL REACH (HYDR)	SLEWING ANGLE	SLEWING TIME	MAX WORKING HEEL	WORKING PRESSURE	CRANE WEIGHT WITHOUT STABILIZERS	OIL TANK CAPACITY	OIL FLOW	DIMENSIONS
	tm	m	°	s/180°	°	bar	kg	l	l/min	mm B x h x S
HV27 E2	2,60	7,93	370	13	4	205	375	17,5	10	1900x1635x352
HV27 E3	-	9,19	370	13	4	205	405	17,5	10	1900x1635x352

HV 47



HV47 E1

kg	4300*	2150*	1325	965	705
m	1,00	2,00	3,23	4,44	5,75

HV47 E2

kg	4170*	2085*	1250	900	705	540
m	1,00	2,00	3,33	4,54	5,75	7,06

HV47 E3

kg	4060*	2030*	1180	845	650	540	425
m	1,00	2,00	3,43	4,64	5,85	7,06	8,37

CE	<input checked="" type="checkbox"/>
NO CE	<input checked="" type="checkbox"/>
MANUAL	<input checked="" type="checkbox"/>
RADIO	<input type="checkbox"/>

*) Theoretical lifting capacity

MODELS	LIFTING MOMENT	MAX VERTICAL REACH (HYDR)	SLEWING ANGLE	SLEWING TIME	MAX WORKING HEEL	WORKING PRESSURE	CRANE WEIGHT WITHOUT STABILIZERS	OIL TANK CAPACITY	OIL FLOW	DIMENSIONS
	tm	m	°	s/180°	°	bar	kg	l	l/min	mm B x h x S
HV47 E1	4,30	7,22	380	16	4	270	565	48	14	2155x1955x420
HV47 E2	-	8,51	380	16	4	270	615	48	14	2155x1955x420
HV47 E3	-	9,81	380	16	4	270	660	48	14	2155x1955x420

HV 77



HV77 E1

kg	7550*	3775*	2195	1560	1140
m	1,00	2,00	3,43	4,79	6,23

HV77 E2

kg	7340*	3670*	2085	1470	1140	870
m	1,00	2,00	3,51	4,87	6,23	7,66

HV77 E3

kg	7130*	3565*	1990	1405	1080	870	665
m	1,00	2,00	3,58	4,94	6,30	7,66	9,05

*) Theoretical lifting capacity

CE	<input checked="" type="checkbox"/>
NO CE	<input checked="" type="checkbox"/>
MANUAL	<input checked="" type="checkbox"/>
RADIO	<input type="checkbox"/>

MODELS	LIFTING MOMENT	MAX VERTICAL REACH (HYDR)	SLEWING ANGLE	SLEWING TIME	MAX WORKING HEEL	WORKING PRESSURE	CRANE WEIGHT WITHOUT STABILIZERS	OIL TANK CAPACITY	OIL FLOW	DIMENSIONS
	tm	m	°	s/180°	°	bar	kg	l	l/min	mm B x h x S
HV77 E1	7,55	7,81	380	16	4	255	770	48	16	2320x2030x565
HV77 E2	-	9,22	380	16	4	255	830	48	16	2320x2030x565
HV77 E3	-	10,64	380	16	4	255	890	48	16	2320x2030x565

HV 107



HV107 E1

kg	9560*	3915**	2425	1720	1230
m	1,00	2,42	3,91	5,56	7,35

HV107 E2

kg	9180*	3770**	2300	1605	1230	895
m	1,00	2,42	3,99	5,64	7,34	9,22

HV107 E3

kg	8880*	3670**	2170	1485	1120	895	675
m	1,00	2,42	4,08	5,73	7,43	9,22	11,17

*) Theoretical lifting capacity
 **) Fixed hook capacity

CE	<input checked="" type="checkbox"/>
NO CE	<input checked="" type="checkbox"/>
MANUAL	<input checked="" type="checkbox"/>
RADIO	<input type="checkbox"/>

MODELS	LIFTING MOMENT	MAX VERTICAL REACH (HYDR)	SLEWING ANGLE	SLEWING TIME	MAX WORKING HEEL	WORKING PRESSURE	CRANE WEIGHT WITHOUT STABILIZERS	OIL TANK CAPACITY	OIL FLOW	DIMENSIONS
	tm	m	°	s/180°	°	bar	kg	l	l/min	
HV107 E1	9,56	9,30	380	15	4	275	1030	100	25	2490X2320X635
HV107 E2	-	11,08	380	15	4	275	1130	100	25	2490X2320X635
HV107 E3	-	12,95	380	15	4	275	1220	100	25	2490X2320X690

HV 147



HV147 E1

kg	13870*	5820**	3455	2485	1815
m	1,00	2,34	3,93	5,58	7,36

HV147 E2

kg	13360*	5655**	3295	2355	1815	1380
m	1,00	2,34	4,01	5,66	7,36	9,23

HV147 E3

kg	12930*	5525**	3160	2250	1715	1380	1015
m	1,00	2,34	4,08	5,73	7,43	9,23	11,14

*) Theoretical lifting capacity
 **) Fixed hook capacity

CE	<input checked="" type="checkbox"/>
NO CE	<input checked="" type="checkbox"/>
MANUAL	<input checked="" type="checkbox"/>
RADIO	<input type="checkbox"/>

MODELS	LIFTING MOMENT	MAX VERTICAL REACH (HYDR)	SLEWING ANGLE	SLEWING TIME	MAX WORKING HEEL	WORKING PRESSURE	CRANE WEIGHT WITHOUT STABILIZERS	OIL TANK CAPACITY	OIL FLOW	DIMENSIONS
	tm	m	°	s/180°	°	bar	kg	l	l/min	mm B x h x S
HV147 E1	13,9	9,54	380	15	4	285	1375	100	25	2500X2455X820
HV147 E2	-	11,3	380	15	4	285	1490	100	25	2500X2455X820
HV147 E3	-	13,1	380	15	4	285	1595	100	25	2500X2455X820

HV 197



HV197 E1

kg	19110*	7965**	4715	3395	2510
m	1,00	2,33	3,98	5,63	7,41

HV197 E2

kg	18600*	7765**	4520	3240	2510	1915
m	1,00	2,33	4,06	5,71	7,41	9,28

HV197 E3

kg	17940*	7610**	4345	3100	2380	1915	1510
m	1,00	2,33	4,13	5,78	7,48	9,28	11,15

*) Theoretical lifting capacity
 **) Fixed hook capacity

CE	<input checked="" type="checkbox"/>
NO CE	<input checked="" type="checkbox"/>
MANUAL	<input checked="" type="checkbox"/>
RADIO	<input type="checkbox"/>

MODELS	LIFTING MOMENT	MAX VERTICAL REACH (HYDR)	SLEWING ANGLE	SLEWING TIME	MAX WORKING HEEL	WORKING PRESSURE	CRANE WEIGHT WITHOUT STABILIZERS	OIL TANK CAPACITY	OIL FLOW	DIMENSIONS
	tm	m	°	s/180°	°	bar	kg	l	l/min	
HV197 E1	19,1	9,35	380	15	4	295	1715	150	40	2500X2475X920
HV197 E2	-	11,0	380	15	4	295	1850	150	40	2500X2475X920
HV197 E3	-	12,8	380	15	4	295	1975	150	40	2500X2475X920

HV 227

LCS



HV227 E1

kg	20520*	8490**	5035	3645	2710
m	1,00	2,33	3,98	5,63	7,41

HV227 E2

kg	20080*	8460**	4835	3485	2710	2075
m	1,00	2,33	4,06	5,71	7,41	9,28

HV227 E3

kg	19370*	8315**	4670	3330	2570	2075	1640
m	1,00	2,33	4,13	5,78	7,48	9,28	11,15

*) Theoretical lifting capacity

**) Fixed hook capacity

CE	<input checked="" type="checkbox"/>
NO CE	<input checked="" type="checkbox"/>
MANUAL	<input checked="" type="checkbox"/>
RADIO	<input type="checkbox"/>

MODELS	LIFTING MOMENT	MAX VERTICAL REACH (HYDR)	SLEWING ANGLE	SLEWING TIME	MAX WORKING HEEL	WORKING PRESSURE	CRANE WEIGHT WITHOUT STABILIZERS	OIL TANK CAPACITY	OIL FLOW	DIMENSIONS
	tm	m	°	s/180°	°	bar	kg	l	l/min	mm B x h x S
HV227 E1	20,5	9,35	380	15	4	315	1745	150	40	2500X2475X945
HV227 E2	-	11,05	380	15	4	315	1880	150	40	2500X2475X945
HV227 E3	-	12,84	380	15	4	315	2005	150	40	2500X2475X945





HW LINE

HW 60

Higher productivity and reliability with waste collection cranes ideal for activities in urban areas

HW 60



PERFECT FOR ALL COLLECTION SYSTEMS

Single ring

Only hook needed.

Waste release in compactor with manual operation.

Double ring

One hook to lift the bin and the second to open/release the waste.

Mushroom

Special attachment needed to open the recycle bin.



WIDE ATTACHMENTS SELECTION



HW 60

CE	✓
NO CE	✗
MANUAL	✗
RADIO	✓

HW60 E2

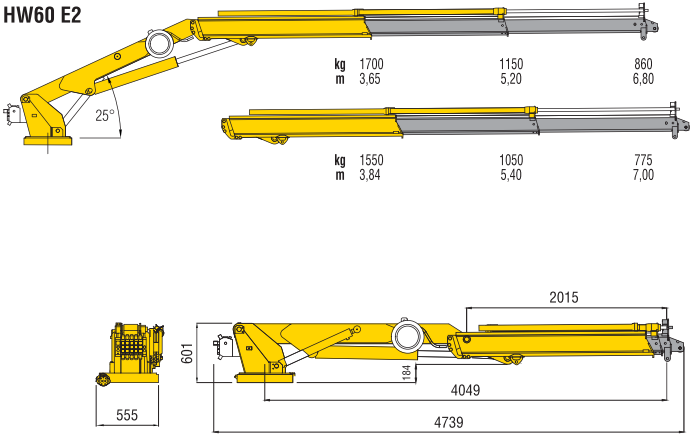

MODELS	LIFTING MOMENT	MAX VERTICAL REACH (HYDR)	MAX ELEVATION HEIGHT FROM THE BASE OF THE CRANE	SLEWING ANGLE	WORKING PRESSURE	CRANE WEIGHT	OIL TANK CAPACITY
	tm	m	m	°	bar	kg	l
HW 60 E2	6,2	6,35	7,02	330	250	750	30



MAN BASKET

HA50 MB
HA70 MB

MAN BASKET



Thanks to the special "self-aligning" balancing system, the position of the basket is always horizontal without any intervention from the user.

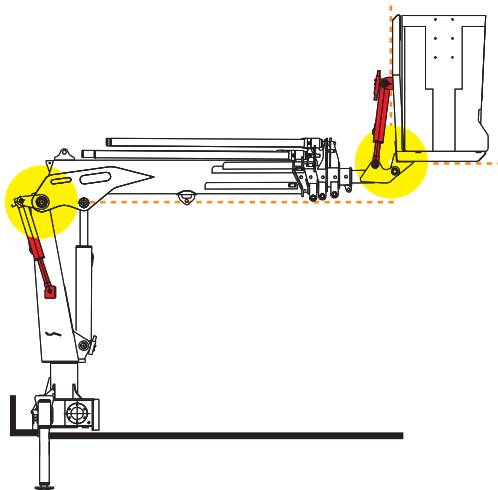

MAN BASKET

CE	<input type="checkbox"/>
NO CE	<input checked="" type="checkbox"/>
MANUAL	<input checked="" type="checkbox"/>
RADIO	<input checked="" type="checkbox"/>

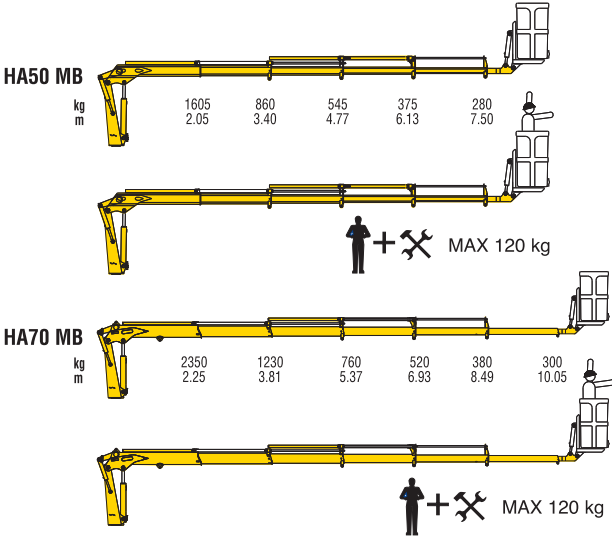

MODELS	LIFTING MOMENT	MAX VERTICAL REACH (HYDR)	SLEWING ANGLE	SLEWING TIME	MAX WORKING HEEL	WORKING PRESSURE	CRANE WEIGHT (STAB. STANDARD)	OIL TANK CAPACITY	OIL FLOW	DIMENSIONS
	tm	m	°	s/180°	°	bar	kg	l	l/min	mm B x h x S
HA50 MB	3,29	13,30	380	-	4	220	940	35	15	3305x1940x850
HA70 MB	5,29	16,00	387	-	4	220	1260	35	18	3765x2080x850



FFB

HB 10S FFB

HB 11 FFB

HB 16 FFB

HB 20 FFB

HB 50 FFB

SPECIALIZED CRANES FOR AGRICULTURAL TRACTORS

Uniquely engineered to support advanced applications in the agricultural industry, the FFB line boosts the productivity and efficiency while enhancing the speed and safety of harvesting activities.



Easy and Safe



Easy to use and maintain

All the greasing points are in an easy to access position.



Internal Hoses

Protection to damage due to possible collision with branches and working conditions.

4 functions control valve by Walvoil



7 functions control valve by Hydrocontrol



Strong and reliable



Structural design in accordance with: EN12999



Quality ISO9001: 2008 certified

Production from the raw metal to the crane ready to be installed is controlled by quality procedures certified by Lloyd's register according to ISO9001.

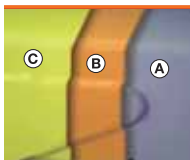

Long life painting

Painting process is made to allow the best quality possible and ensure a long crane life in all the applications and environments.

- A - Iron grid sandblasting
- B - Cathodic electrodeposition paint
- C - Yellow polyester powder paint



Hexagonal boom

The use of this technology brings superior performance, reduced maintenance, and less adjustment.

Strong and reliable

Reinforced rack, pinion and gear

(for HB11 - HB15)

Heavy duty application and long life resistance.

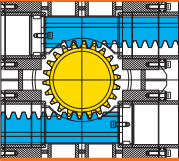

Double rack and pinion heavy duty slewing

(for HB20 - HB50) The use of two racks spread the force across twice as many teeth on the pinion. Slewing has more strength for difficult situations.

Internal extension cylinder

(for HB50)

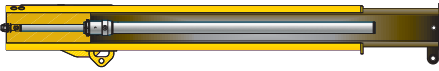

Floating device

Free boom movements to follow field inclination during transport.

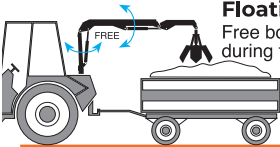

Key attachments



3 Jaws grab

Self weight: 35 kg

Capacity: 50 dm³



4 jaws grab

Self weight: 75 kg

Capacity: 100 dm³



box grab

Special attachment for bulk material.



EFB (Empty Fruit Bunch) grab

Self weight: 60 kg

Capacity: 120 dm³



Turnkey solution



Piston Pump & Trac Power

High speed performance for mid-high size models.



Oil tank

Steel oil tank made to be installed on the back of the tractor including oil filter and level indicators.



Stabilizers (for HB50)

Allow higher stability of the tractor during loading/unloading operation.



HB10S FFB

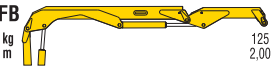

HB11 FFB

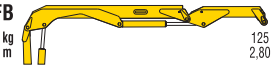

HB16 FFB

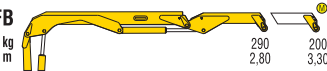

HB20 FFB

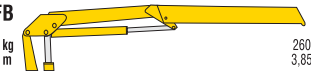

HB50 FFB



Manual extension (weight kg 10)

CE	<input type="checkbox"/>
NO CE	<input checked="" type="checkbox"/>
MANUAL	<input checked="" type="checkbox"/>
RADIO	<input type="checkbox"/>

MODELS	LIFTING MOMENT	MAX VERTICAL REACH (HYDR)	SLEWING ANGLE	SLEWING TIME	MAX WORKING HEEL	WORKING PRESSURE	CRANE WEIGHT WITHOUT MANUAL EXTENSION	OIL TANK CAPACITY	OIL FLOW	RACOMMENDED TRACTOR
	tm	m	°	s/180°	°	bar	kg	l	l/min	hp
HB10S FFB	0,25	3,1	330	4	10	70	168	25	12	Crawler/super bull
HB11 FFB	0,35	3,7	330	4	10	90	195	25	12	
HB16 FFB	0,81	3,7	330	4	10	160	198	46	12	
HB20 FFB	0,90	5,7	370	4	4	135	202	35	12	
HB50 FFB	4,74	6,7	380	18	4	275	675	35	15	





13 - RL
14 - R
16 - R
R - 20
R - 24
R - 30
R - 40

The Kennis Concept - Maximize The Haulage Payload And Increase Your Productivity.

Fast Operation

Longer Useful Life

Efficient, Simpler & Safer For Users.

Improved Driving Condition

Maximum Payload



HIGH LIFTING CAPACITY AND LOW TARE

The complete Kennis Rolloader concept is the combination of a light crane, light attachment and equally important a light trailer. Kennis Rolloader Cranes are made to perform many cycles at high speed and with exceptional precision. With a lightweight, compact design and a short boom, Kennis cranes can do the same heavy job with a lower load moment (capacity) than a heavy rear mounted crane which will require a long boom. The steel structures of crane and crane equipment have been engineered to perform and endure tough heavy duty load cycles making the crane fast, extremely robust and durable while still very safe to operate.

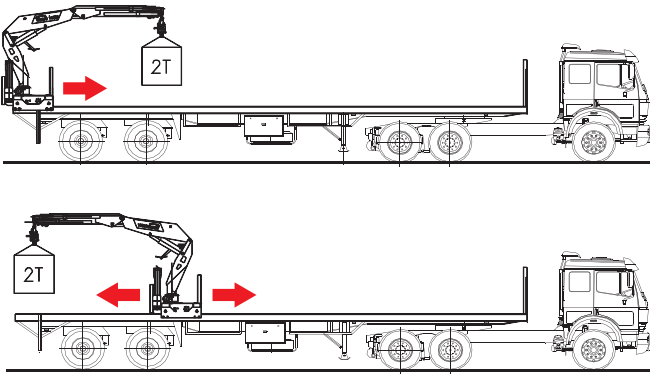

UNRESTRICTED VIEW FROM ITS ERGONOMIC CONTROL

- Better visibility so as to view loading and unloading operations.
- Simple, safe intuitive control.
- Precise and advanced top seat control with levers or four-axis joystick control and foot pedals.
- Ergonomically designed topseat and crane control joysticks improves comfort leading to efficiency, and also increases safety.

RADIO REMOTE CONTROL



Multifunction radio remote control allows the operator to move 2-3-4 or more functions of the crane simultaneously, and to move freely around the trailer and keep control of the load position.

ENVIRONMENTALLY FRIENDLY

- Lower total tare weight so maximum payload is transported.
- Self-propelled crane with its own high performance fuel efficient power unit.
- Variable displacement pump using optimum power resulting in less fuel consumption.



EFFICIENCY

- Faster loading cycle speeds.
- Load/ Unload independently without the use of any other handling equipment on site.
- The crane operation is closer to the load with a shorter boom maximizing the load capacity.
- Self-propelled powered base eliminates the necessity of moving your truck while loading, saving valuable time.
- A precise control of the crane's movement and for accurate placing of the load.
- Easily offload the crane from the trailer.

LONGER USEFUL LIFE

A Kennis crane mounted on the trailer outlasts the useful life far longer than the tractor head truck. Different fleet of tractor heads can also be used for multiple other applications making the operations more flexible as it does not need to have specially fitted hydraulic kits to power the crane.

- Continuous slewing
- Hexagonal boom sections
- Twin high performance lift cylinders

E-Power helps to meet increasingly demanding environmental regulations, with direct tax benefits for the customers in certain countries.



BATTERY PACK AND MOTOR

Electric motors used, feature Kennis integrated electric motors (IEM) and batteries with a new generation of power semiconductors, to achieve best in class efficiency.

CONSTANT TORQUE

Kennis electric motors matches robustness and power by providing the correct torque and constant angular speed to drive the hydraulic pump.

URBAN USE

The electric crane solution is ideal for urban areas and can be operated when the truck engine is switched off.

Kennis e-power cranes lead a pioneering role in the field of electrification and are the latest high-performance innovations, maintaining the best advantages in service and payload.

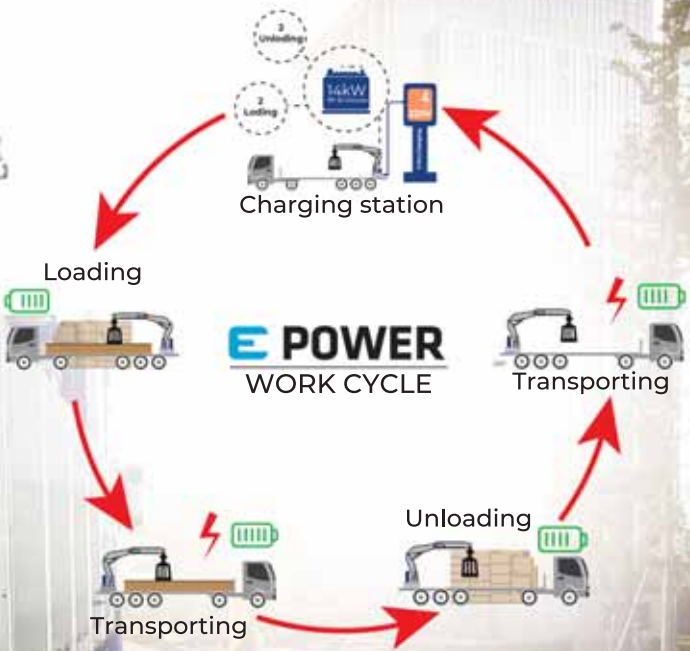

GOING THE EXTRA MILE

Kennis ORRS (On-Road Recharging System). provides energy to recharge service battery from traction battery energy.

FAST RECHARGE

High capacity battery pack, built to deliver maximum energy, without compromising power performances. Battery Management System (BMS) guarantee efficient thermal management, high battery performance and safety.

EFFICIENT ENERGY DISTRIBUTION

High voltage power connection provides for the use of shielded cable with high efficient inner core cross section area.

13-RL

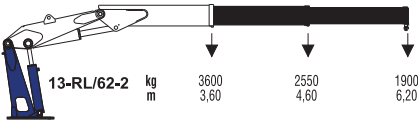

14-R

E POWER
Versions
available

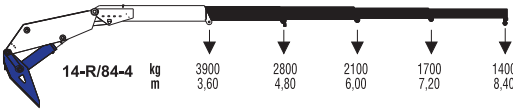
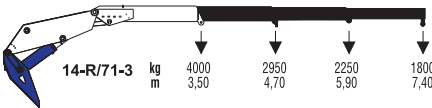
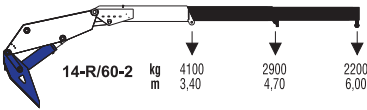
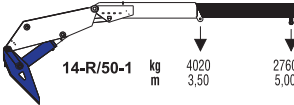

16-R

E POWER
Versions
available

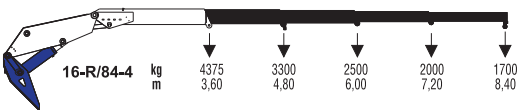
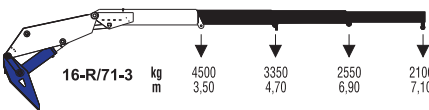
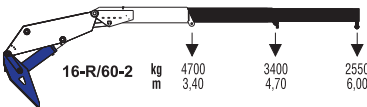

R-20

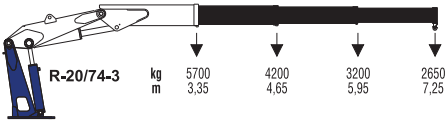

R-24

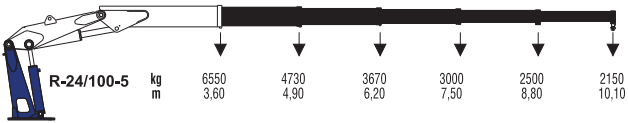
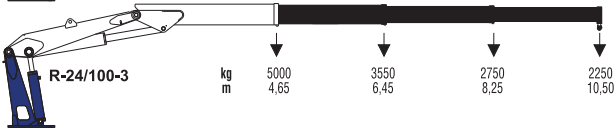
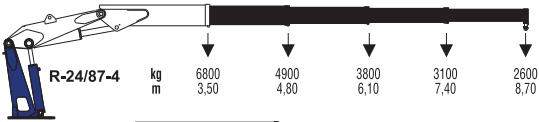
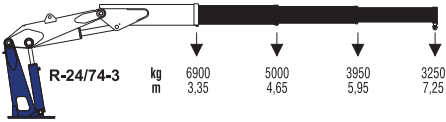

R-30

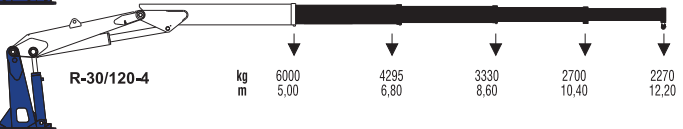
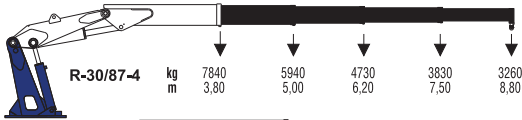
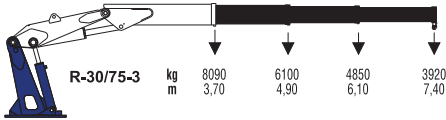

R-40

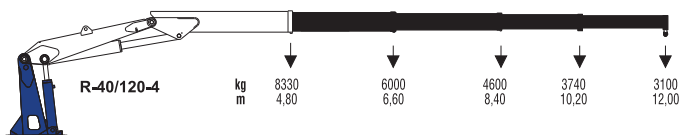
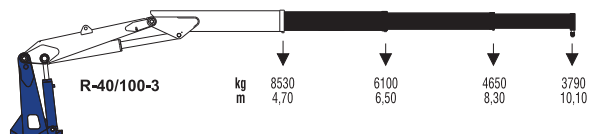
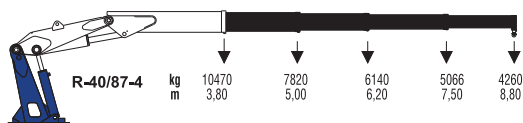
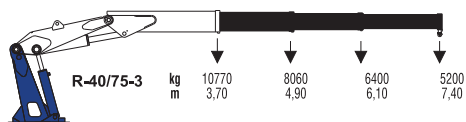

MODELS	LIFTING MOMENT	MAX HYDRAULIC REACH	FOLDABLE	SLEWING ANGLE	HEIGHT	WIDTH	CRANE WEIGHT	LENGTH FOLDED CRANE
	tm	m		°	mm	mm	kg	mm
13-R/62-2	13	6,2	Yes	405	2392	2408	2000	1000
14-R/50-1	14	5,0	Yes	400	2530	2550	2900	1082
14-R/60-2	14	6,0	Yes	400	2440	2550	3000	1082
14-R/71-3	14	7,1	Yes	400	2530	2550	3100	1082
14-R/84-4	14	8,4	Yes	400	2570	2550	3200	1082
16-R/60-2	16	6,0	Yes	400	2440	2550	3100	1082
16-R/71-3	16	7,1	Yes	400	2530	2550	3200	1082
16-R/84-4	16	8,4	Yes	400	2570	2550	3300	1082
R-20/74-3	20	7,4	Yes	Endless	2470	2515	4090	1350
R-24/74-3	24	7,3	Yes	Endless	2470	2515	4290	1370
R-24/87-4	24	8,7	Yes	Endless	2550	2515	4450	1370
R-24/100-3	24	10,0	No	Endless	2250	2515	4500	-
R-24/100-5	24	10,1	Yes	Endless	2550	2515	4620	1370
R-30/75-3	30	7,5	Yes	Endless	2470	2515	5400	1590
R-30/87-4	30	8,7	Yes	Endless	2550	2515	5550	1590
R-30/100-3	30	10,3	No	Endless	2300	2515	5750	-
R-30/120-4	30	12,2	No	Endless	2300	2515	6000	-
R-40/75-3	40	8,2	Yes	Endless	2470	2525	6140	1590
R-40/87-4	40	8,8	Yes	Endless	2550	2525	6300	1590
R-40/100-3	40	10,1	No	Endless	2360	2525	6500	-
R-40/120-4	40	12,0	No	Endless	2360	2525	6800	-



Data, descriptions, and illustrations pertain only and uniquely to models sold at the time of printing of this brochure. After the date of printing, this information is purely indicative and not binding upon HYVA. Future modifications are solely at the discretion of HYVA and are always in compliance with applicable and pertinent safety standards. To obtain updated data, descriptions, and illustrations, contact the manufacturer or your reseller. Cranes manufactured and/or marketed by HYVA, HYVA is not responsible for the special applications depicted. Crane applications and accessories described herein are only examples. Some applications and equipment shown may not be approved for use in CE countries or other areas. It is the installer's responsibility to ensure that the crane is applied correctly, and that its application, installation, and accessories maintain safety and comply with all local laws.

110 countries
+3,500 employees
20,000 customers
+30 subsidiaries
14 production facilities

Tipping Solutions | Container Handling | Waste Handling | Cranes

Hyva is a leading provider of innovative and highly efficient transport solutions for commercial vehicles used in transport, construction, mining, materials handling and environmental service industries.

Founded in 1979 in the Netherlands, the company has a global presence with more than 30 wholly owned subsidiaries, extraordinary service coverage and 14 manufacturing facilities in Brazil, China, Europe and India.

For more information on Hyva, please visit www.hyva.com

or follow us on:



ISO 9001 • ISO 14001
Quality and
environmental certified

Hyva Holding B.V.

Antonie van Leeuwenhoekweg 37
2408 AK Alphen aan den Rijn
The Netherlands
Telephone: +31 (0)172 - 42 35 55
Telefax: +31 (0)172 - 42 08 80
info@hyva.com
www.hyva.com

DEALER STAMP

Data, descriptions, and illustrations pertain only and uniquely to models sold at the time of printing of this brochure. After the date of printing, this information is purely indicative and not binding upon HYVA. Future modifications are solely at the discretion of HYVA and are always in compliance with applicable and pertinent safety standards. To obtain updated data, descriptions, and illustrations, contact the manufacturer or your reseller. Cranes manufactured and/or marketed by HYVA. HYVA is not responsible for the special applications depicted. Crane applications and accessories described herein are only examples. Some applications and equipment shown may not be approved for use in CE countries or other areas. It is the installer's responsibility to ensure that the crane is applied correctly, and that its application, installation, and accessories maintain safety and comply with all local laws.